

AquaCal® Operation Manual

HEATWAVE SUPERQUIET®



TropiCool® WATER CHILLER

SMART CONTROLLER ENABLED

Important

Read this document before operating / installing this product

For additional product manuals and operation / installation procedures, please visit www.AquaCal.com

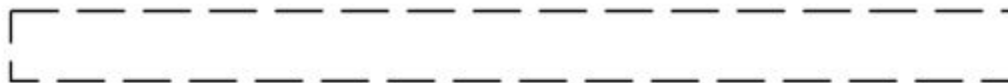

MODEL / SERIAL NUMBER

Table of Contents

Contacting AquaCal AutoPilot, Inc.	1
Safety Instructions	1
1 - Operation	3
1.1 Display Door	3
1.2 Wake Up Heat Pump	3
1.3 Display Panel	4
1.4 Activate Heat Mode, Cool Mode, Auto Mode, or Deactivate Equipment	6
1.5 Set Temperature	7
1.6 Set Up Programming	7
1.6.a Factory Defaults	7
1.6.b Selecting Celsius or Fahrenheit	8
1.6.c Setting Date and Time	9
1.6.d Setting Date and Time Format	10
1.6.e Using Entry Code to Access Heat Pump	13
1.6.f Setting Entry Code Option	13
1.6.g Disabling Entry Code Option	15
1.7 External Equipment	16
1.7.a Operating Heat Pump with a Call Flex	16
1.7.b Operating Heat Pump (With an External Controller)	19
1.7.c Operating Heat Pump (With an External Flow Switch)	19
1.7.d Operating Heat Pump (With a Gas Back Up)	19
d.1 Using Gas Boost	20
d.2 Changing a Gas Backup Heater's Schedule	22
1.7.e Operating Multiple Connected Heat Pumps	24
2 - Maintenance	25
2.1 Water Chemistry	25
2.2 Cleaning Equipment	26
2.3 Clearances	27
2.4 Irrigation and Storm Run-Off	27
2.5 Water Flow Rates	28
2.6 Adjusting Water Flow Using ΔT (Delta-T)	29
2.7 Planned Maintenance	30
2.8 Winterizing	31
3 - Troubleshooting	33
3.1 Fault Codes	33
3.2 Issues and Resolutions	37
4 - Appendix	43
4.1 Identifying Model Specifications	43
4.2 Weights	44
4.3 Heating Recommendations	44
4.4 Cooling Recommendations	45
4.5 Available Accessories	45

Contacting AquaCal AutoPilot, Inc.

For further assistance, please contact the distributor or installer of this product.

If unavailable, please contact AquaCal® for a partner in your area. To better assist you, please have the heat pump model and serial number available.

- See "Identifying Model Specifications" on page 43.



Product Information:	
Website	www.AquaCal.com
Phone	(1) 727-823-5642
Hours	8-5 pm, Eastern M-F

Service Information:	
Website	www.AquaCal.com/request-heat-pump-service/

SAFETY INSTRUCTIONS

- For personal safety, and to avoid damage to equipment, follow all safety instructions displayed on the equipment and within this manual. Repair and service of heat pump must be performed by an authorized service center.
- Warranties may be voided if the equipment has been improperly installed, maintained or serviced.
- If service is deemed necessary, please see "Contacting AquaCal AutoPilot, Inc." on page 1.

SAFETY SIGNALS
Throughout this document, safety signals have been placed where particular attention is required.

	Failure to heed the following will result in injury or death.
	Failure to heed the following may result in injury or death.
	Failure to heed the following may result in damage to equipment.

When installing and using your heat pump basic safety precautions must always be followed, including the following:

 Failure to heed the following will result in injury or death.

- The heat pump utilizes high voltage and rotating equipment. Use caution when servicing.



Failure to heed the following may result in injury or death.

- Installation and repairs must be performed by a qualified technician.
- The heat pump contains refrigerant under pressure. Repairs to the refrigerant circuit must not be attempted by untrained and / or unqualified individuals. Service must be performed only by qualified HVAC technicians. Recover refrigerant before opening the system.
- Improper water chemistry can present a serious health hazard. To avoid possible hazards, maintain pool / spa water per standards as detailed in this document.
- Prolonged immersion in water warmer than normal body temperature may cause a condition known as Hyperthermia. The symptoms of Hyperthermia include unawareness of impending hazard, failure to perceive heat, failure to recognize the need to exit the spa, and unconsciousness. The use of alcohol, drugs, or medication can greatly increase the risk of fatal Hyperthermia. In addition, persons having an adverse medical history, or pregnant women, should consult a physician before using a hot tub or spa. Children and the elderly should be supervised by a responsible adult.
- Prolonged immersion in water colder than normal body temperature may cause a condition known as Hypothermia. The symptoms of Hypothermia include shivering (although as hypothermia worsens, shivering stops), clumsiness or lack of coordination, slurred speech or mumbling, confusion and poor decision-making, drowsiness or low energy, lack of concern about personal welfare, progressive loss of consciousness, weak pulse and slow or shallow breathing. In addition, persons having an adverse medical history, or pregnant women, should consult a physician before immersing in a cold body of water. Children and the elderly should be supervised by a responsible adult.

NOTICE

Failure to heed the following may result in damage to equipment.

- Maintain proper water chemistry in order to avoid damage to pump, filter, pool shell, etc.
- Water flow exceeding maximum flow rate requires a bypass. Damage due to excessive water flow will void warranty.

SAVE THESE INSTRUCTIONS

1 - Operation

IN THIS SECTION:

1.1 Display Door	3
1.2 Wake Up Heat Pump	3
1.3 Display Panel	4
1.4 Activate Heat Mode, Cool Mode, Auto Mode, or Deactivate Equipment	6
1.5 Set Temperature	7
1.6 Set Up Programming	7
1.6.a Factory Defaults	7
1.6.b Selecting Celsius or Fahrenheit	8
1.6.c Setting Date and Time	9
1.6.d Setting Date and Time Format	10
1.6.e Using Entry Code to Access Heat Pump	13
1.6.f Setting Entry Code Option	13
1.6.g Disabling Entry Code Option	15
1.7 External Equipment	16
1.7.a Operating Heat Pump with a Call Flex	16
1.7.b Operating Heat Pump (With an External Controller)	19
1.7.c Operating Heat Pump (With an External Flow Switch)	19
1.7.d Operating Heat Pump (With a Gas Back Up)	19
1.7.e Operating Multiple Connected Heat Pumps	24

1.1 Display Door

The display panel is located in a door compartment on the front of the heat pump. This compartment is designed to protect the display against harsh weather. It can also be padlocked for extra security.

- Press the **bottom** of the panel to open the display panel door.
- To close, push the display panel up. Then press the **bottom** of the panel in until a clicking noise is heard.

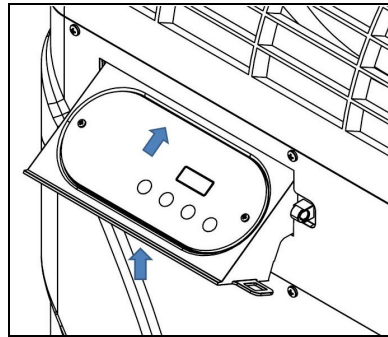
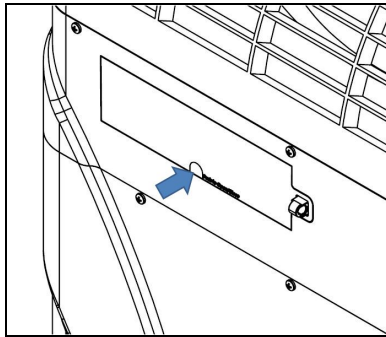

1.2 Wake Up Heat Pump

The display back light will be off when the heat pump is in sleep mode. To wake up the heat pump, slowly slide a finger across the buttons.

- The display will illuminate.
- The message "KEYPAD UNLOCKED" will briefly appear.
- Then the water temperature and mode will display.

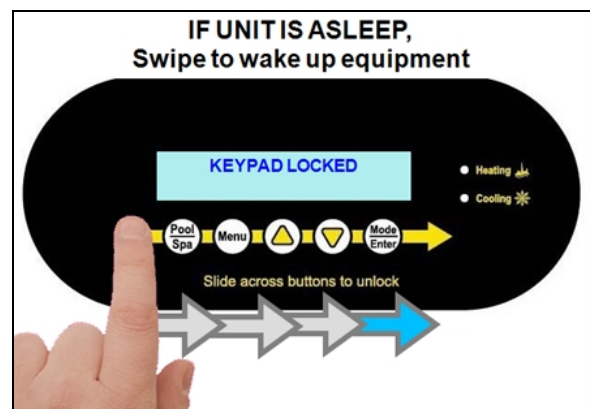

1.3 Display Panel

The following information outlines the operation for a standard installation.

- Control Buttons will operate differently for custom installations; such as when a heat pump is connected to an external controller or multiple heat pump configuration.
 - See "Operating Heat Pump (With an External Controller)" on page 19.
 - See "Operating Multiple Connected Heat Pumps" on page 24.

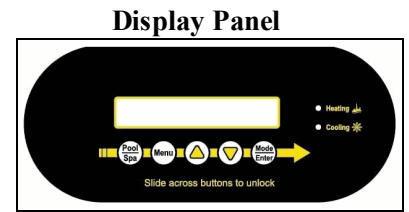

Buttons

Buttons	Description
	Slowly slide a finger across the buttons from left to right to disable the sleep mode. Sleep mode will automatically reactivate after three minutes have passed.
	Select either the pool or the spa thermostat.
	Enter user menu for heat pump options.
	Used to increase temperature set point and navigate through menu options.
	Used to decrease temperature set point and navigate through menu options.
	Used to select heat pump's operating mode. Also used to edit or confirm options in a menu.

Indicator Lights

Indicators	Description
Heating	Red LED indicates the unit is heating the water.
Cooling	Blue LED indicates the unit is cooling the water.
When calling for heating or cooling, up to a three minute delay may occur before compressor starts. The compressor must be operating before the indicator will illuminate.	

Display

	Display	Description
No water flow	NO WATER FLOW HEAT SETPOINT 75°F	No water flow is detected. The filter pump is off or heat pump is not receiving correct water flow.
Primary Heat Pump	POOL TEMP MASTER UNIT 71°F	Primary heat pump controlling other connected heat pumps
Remote Controlled - by master (primary) Heat Pump	WATER TEMP SLAVED UNIT 01 71°F	Heat Pump is set to be controlled by another connected heat pump.
Remote Controlled - by external controller	WATER TEMP UNDER REMOTE CONTROL 75°F	Heat Pump is set to be controlled by an external controller.
Set to 75° F - Maintaining	POOL TEMP AUTO SETPOINT 70°F 75°F	Maintaining a water temperature set on the thermostat. In this example the pool thermostat has been set to 75° F.
Set to 45° F - Cooling	POOL TEMP COOL SETPOINT 70°F 45°F	Cooling water to point set on thermostat. In this example the pool thermostat has been set to 45° F.
Set to 75° F - Heating	POOL TEMP HEAT SETPOINT 70°F 75°F	Heating water to point set on thermostat. In this example the pool thermostat has been set to 75° F.
Set to Off	POOL TEMP HEAT PUMP OFF 70°F	The heat pump has been deactivated using the "Mode / Enter" button.
Entry code required	ENTRY CODE 00	The heat pump has a user lock enabled. See "Using Entry Code to Access Heat Pump" on page 13.

1.4 Activate Heat Mode, Cool Mode, Auto Mode, or Deactivate Equipment

Press "Mode / Enter" button until desired mode is displayed.

- HEATING MODE- After fan and compressor starts, the red "Heating" light will activate.
- COOLING MODE - After fan and compressor starts, the blue "Cooling" light will activate.
- AUTO MODE - After fan and compressor starts, the heat pump will maintain the set temperature within 1°. The red "Heating" or blue "Cooling" light will activate.
- OFF - The heat pump will indicate it is deactivated. The current water temperature will be displayed.

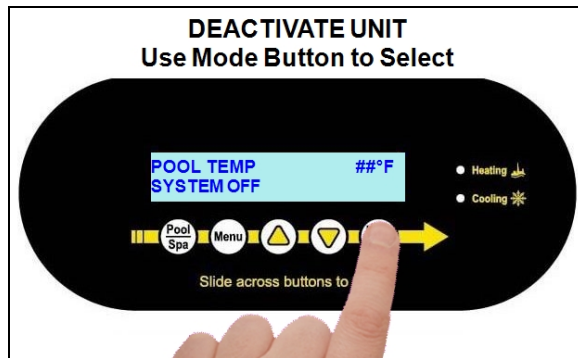
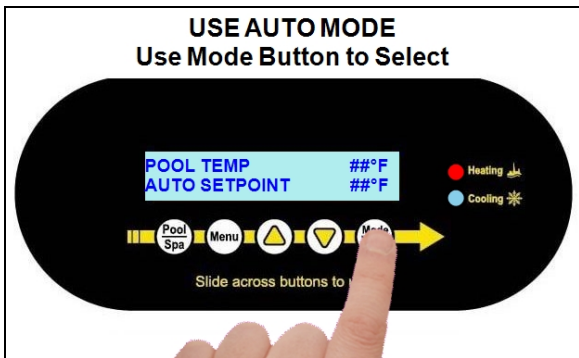
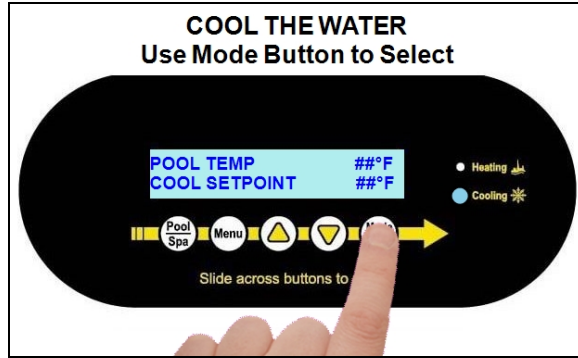
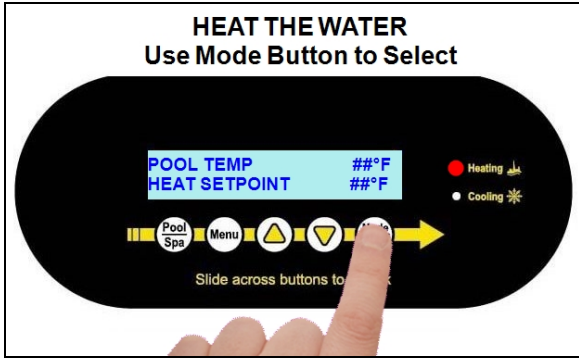

1.5 Set Temperature

Select the pool or spa thermostat. Then press the up or down arrow to set a desired temperature (set point) for the water.

- The heating indicator will illuminate when heating the water.
- The cooling indicator will illuminate when cooling the water.

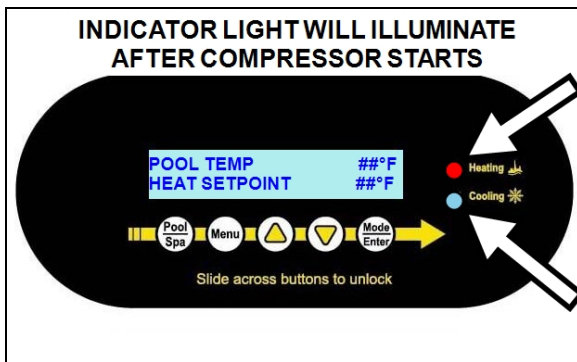
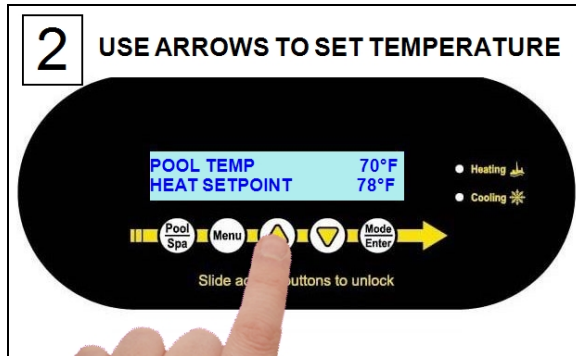
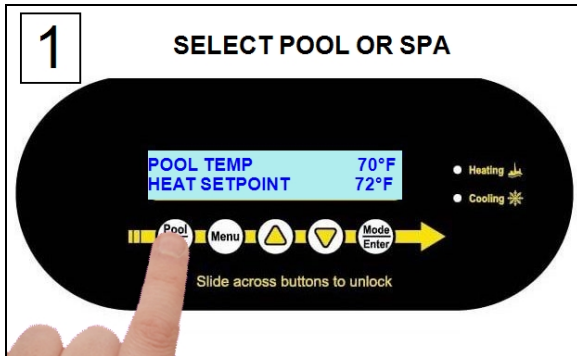

1.6 Set Up Programming

1.6.a Factory Defaults

Certain options have been preset at the factory. These options can be overwritten for site-specific conditions.

NOTICE

Failure to heed the following may result in damage to equipment.

- Unauthorized adjustments in the Installer or Service Menus may void heat pump's warranty.

FACTORY DEFAULTS		
MENUS	DEFAULT	OPTIONS
SET GAS BOOST	OFF	OFF ON
SET TIME / DATE	USER TO SET	
SET TIME FORMAT	12 Hour	12 Hour 24 Hour
SET DATE FORMAT	MDY	MDY DMY

FACTORY DEFAULTS		
MENUS	DEFAULT	OPTIONS
SET TEMPERATURE UNITS	Fahrenheit	Fahrenheit Celsius
SET BACKUP HEAT MODE	OFF	OFF SCHEDULED 24HR
SET BACKUP GAS START	9:00 AM	
SET BACKUP GAS END	5:00 PM	
SET ENTRY CODE ENABLED	OFF	OFF ON
SET USER ENTRY CODE	01	
SET CALL-FLEX MODE	OFF	OFF CALL FLEX

1.6.b Selecting Celsius or Fahrenheit

The user has the option of changing the way the water temperature is displayed. Either in Fahrenheit or Celsius.

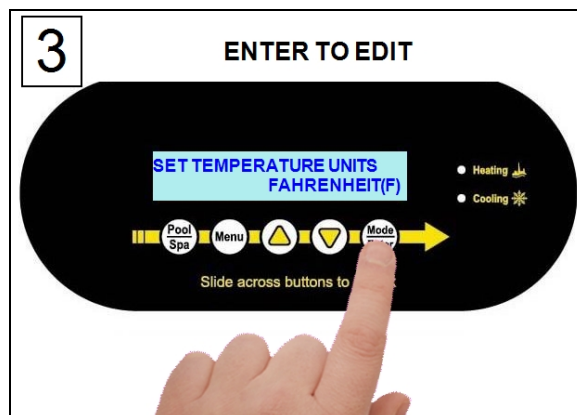
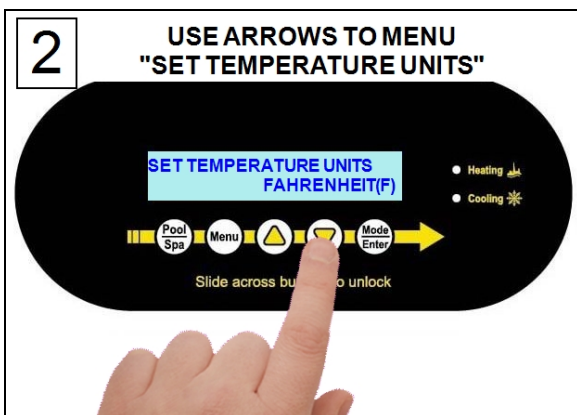
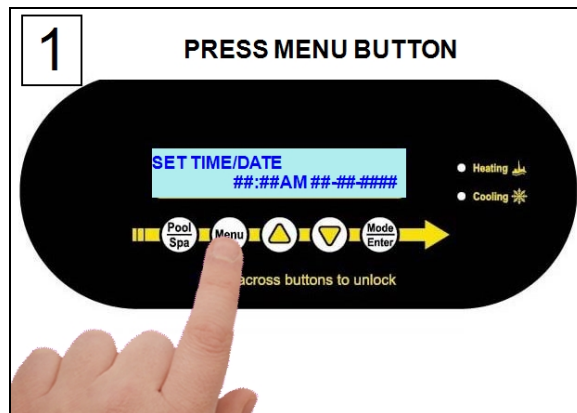
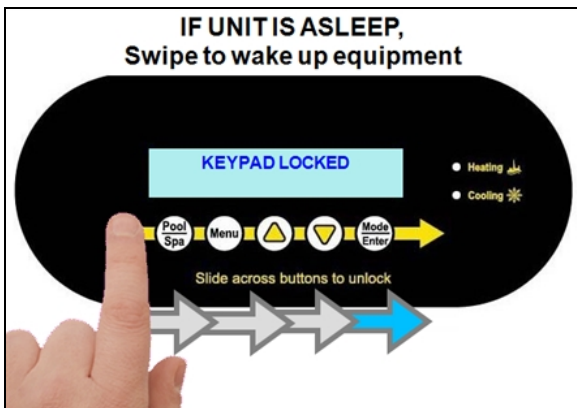

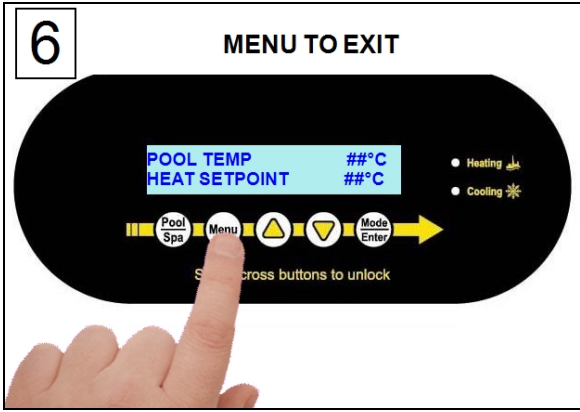
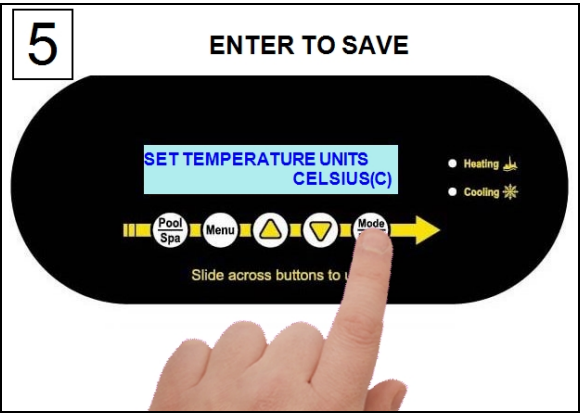
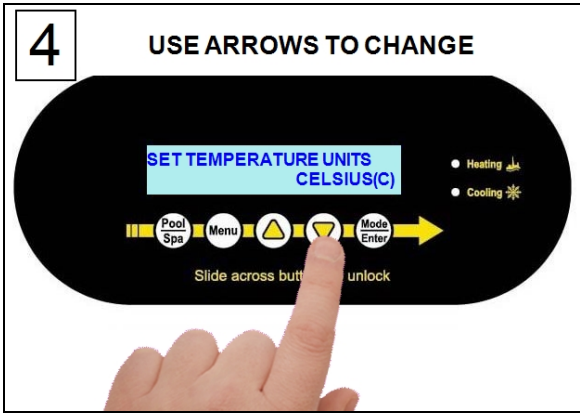

1.6.c Setting Date and Time

Set the heat pump's time and date using the following steps.

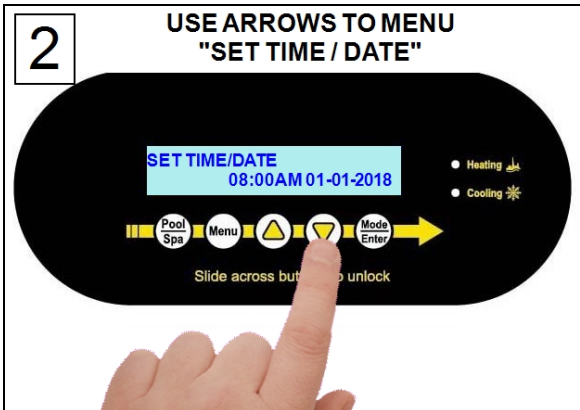
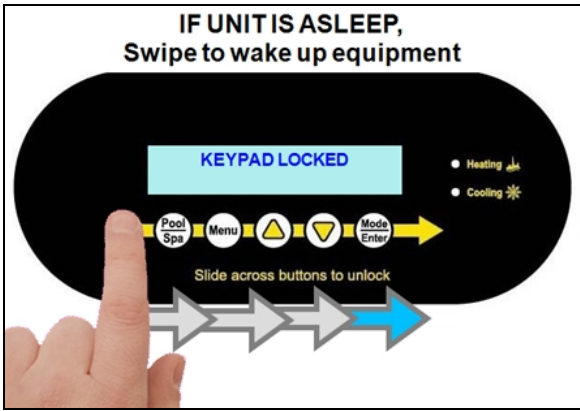

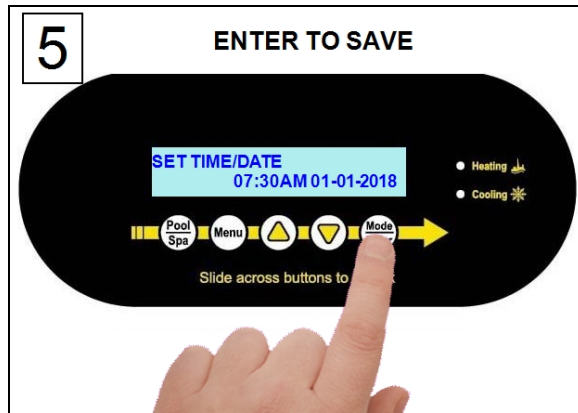
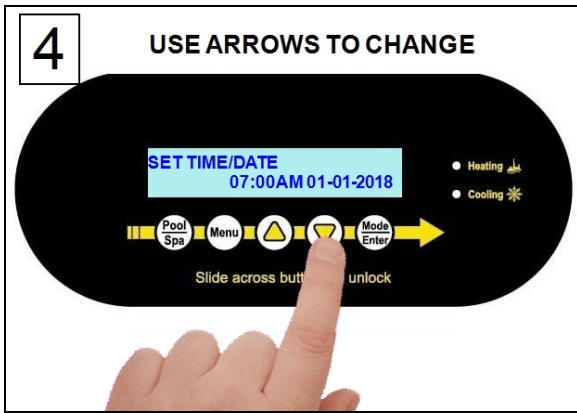

1.6.d Setting Date and Time Format

The heat pump's time and date format can be customized.

Customize Time

The time can be displayed in 24 hour *military* time (the default display is 12 hour).

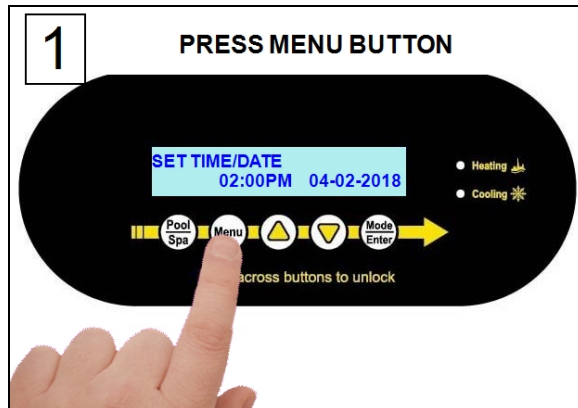
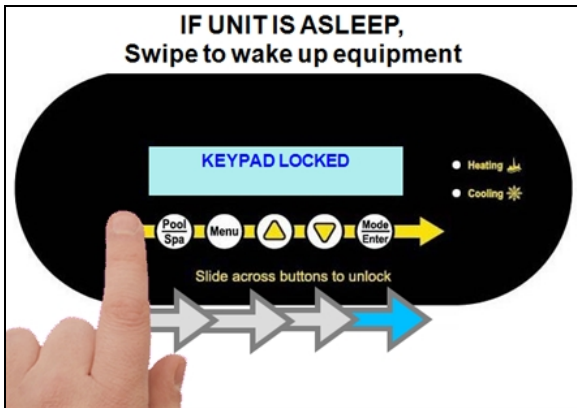

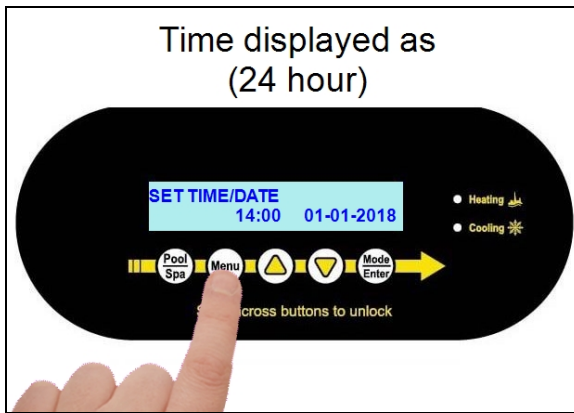
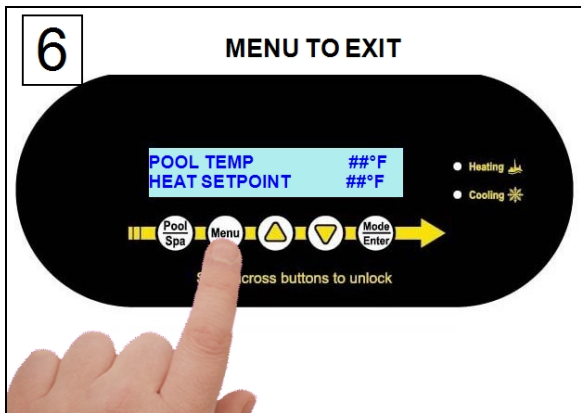
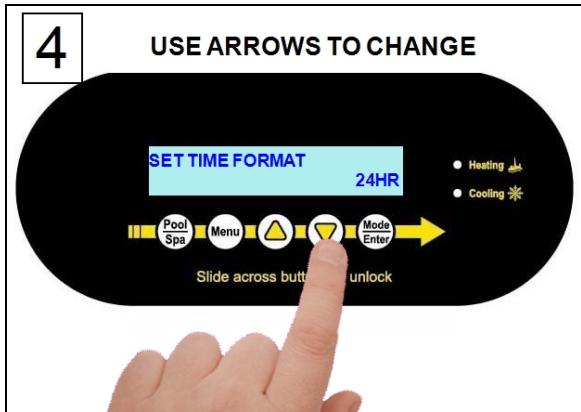
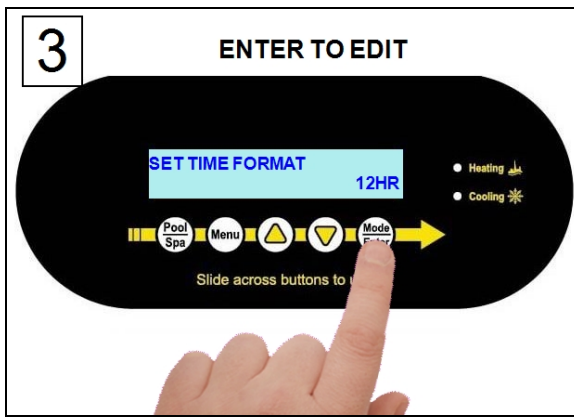
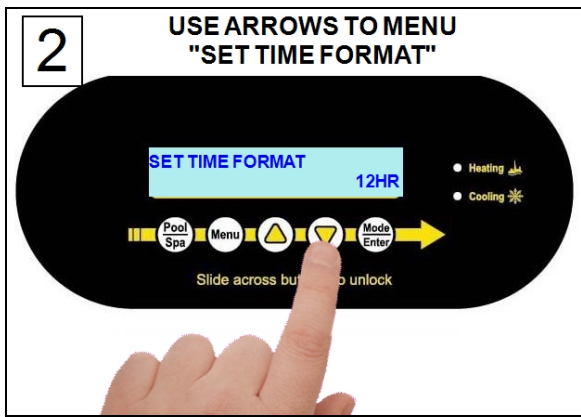

Customize Date

The date can be displayed as Day-Month-Year (the default is Month-Day-Year).

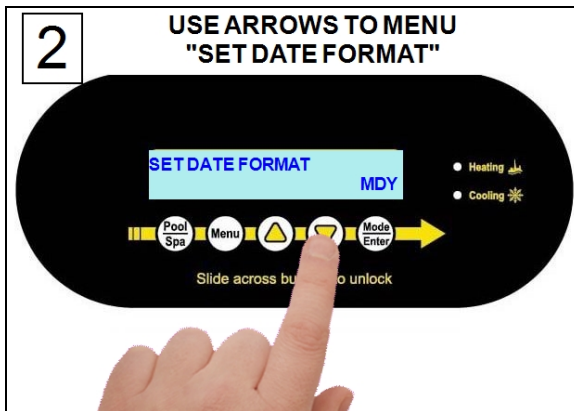

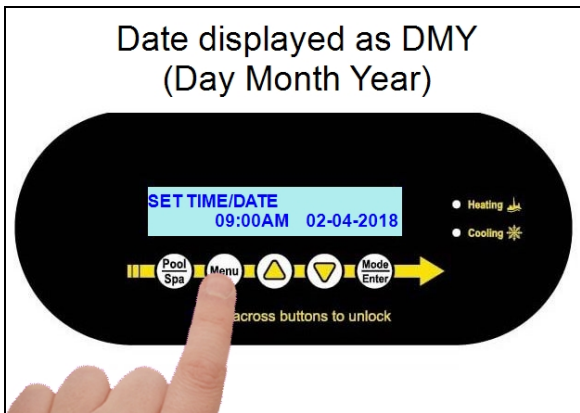
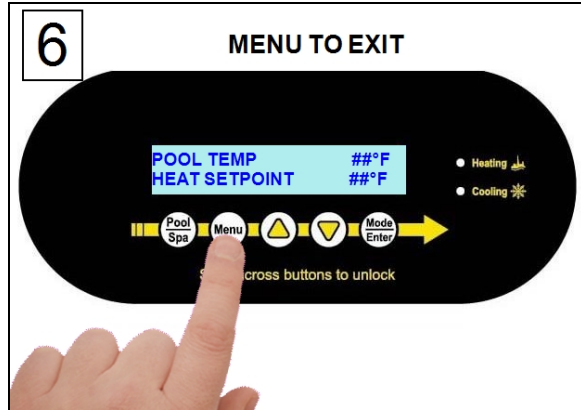
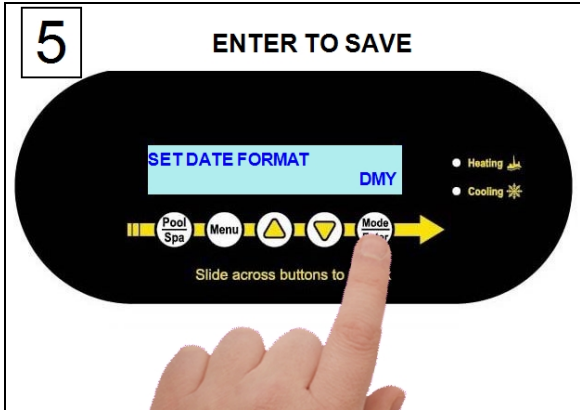
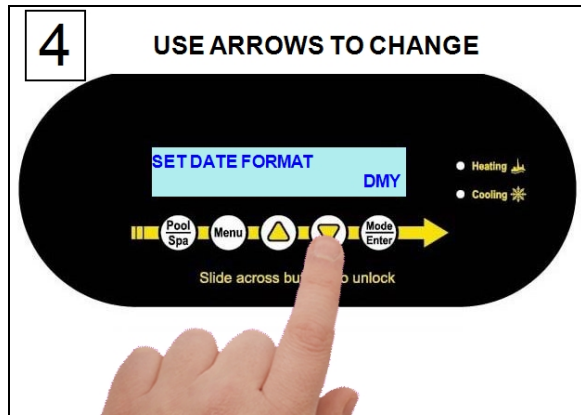
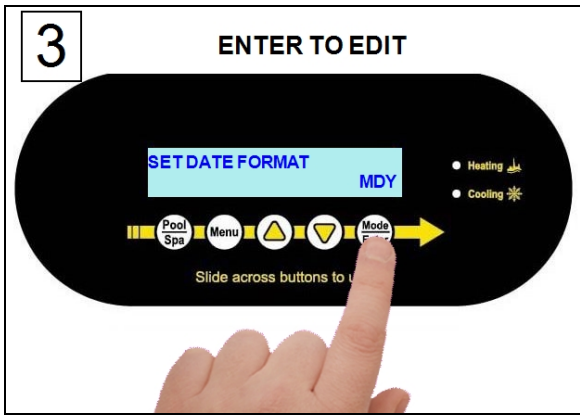

1.6.e Using Entry Code to Access Heat Pump

If a user entry code has been enabled in the user menu, an entry code will be required to access heat pump options.

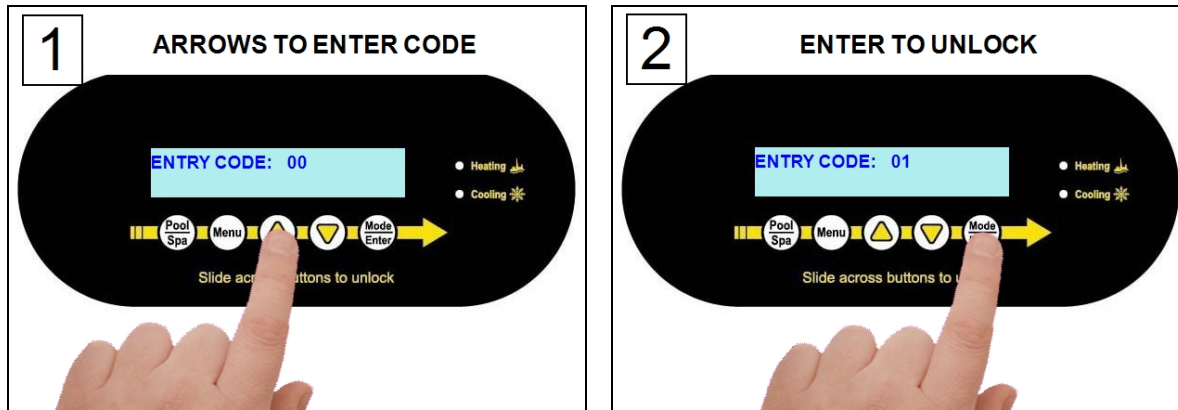

PLEASE NOTE -

- If the entry code has been misplaced, the heat pump will need to be reset to factory defaults.
- After three minutes of inactivity, the heat pump's sleep mode will activate. See "Wake Up Heat Pump" on page 3.

1.6.f Setting Entry Code Option

The entry code feature can prevent unauthorized temperature adjustments. This feature initiates after the heat pump goes into the sleep mode for the first time.

NOTICE

Failure to heed the following may result in damage to equipment.

- **Before enabling the entry code feature, be sure to record the code.** If lost, the heat pump will require a program reset to regain access. This reset may require additional configuration by the installer.

PLEASE NOTE -

A heat pump requesting an entry code is different than the control panel's sleep mode. (See Wake Up Heat Pump on page 3 for more information.)

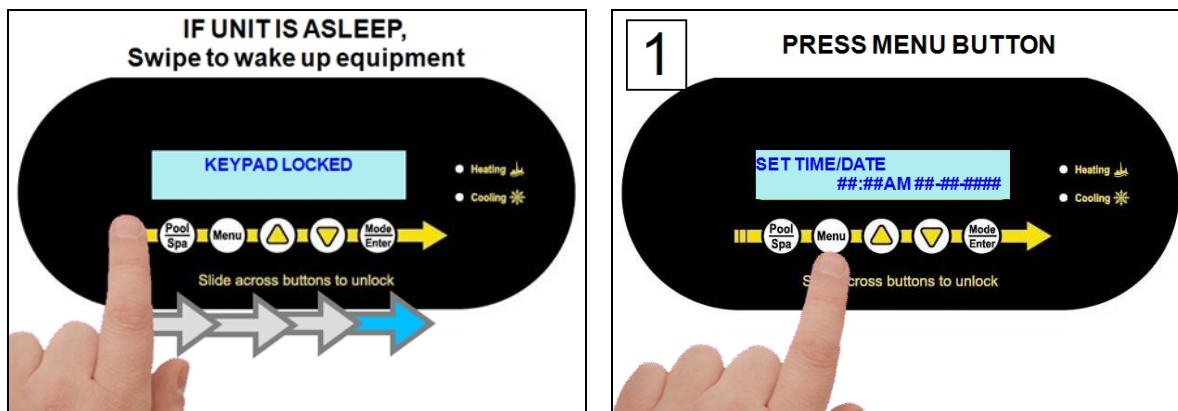

2 USE ARROWS TO MENU "SET USER ENTRY CODE"

Slide across buttons to unlock

Heating
 Cooling

Pool Spa Menu Mode Enter

3 ENTER TO EDIT

Slide across buttons to

Heating
 Cooling

Pool Spa Menu Mode Enter

4 USE ARROWS TO CHANGE

Slide across buttons to unlock

Heating
 Cooling

Pool Spa Menu Mode Enter

5 ENTER TO SAVE

Slide across buttons to

Heating
 Cooling

Pool Spa Menu Mode Enter

6 USE ARROWS TO MENU "SET USER CODE ENABLED"

Slide across buttons to unlock

Heating
 Cooling

Pool Spa Menu Mode Enter

7 ENTER TO EDIT

Slide across buttons to

Heating
 Cooling

Pool Spa Menu Mode Enter

8 USE ARROWS TO CHANGE

Slide across buttons to unlock

Heating
 Cooling

Pool Spa Menu Mode Enter

9 ENTER TO SAVE

Slide across buttons to

Heating
 Cooling

Pool Spa Menu Mode Enter

10

MENU TO EXIT

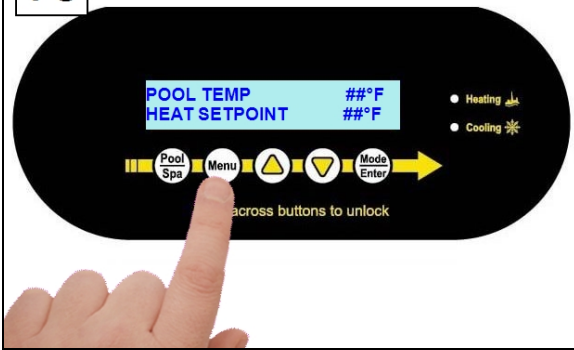

1.6.g Disabling Entry Code Option

PLEASE NOTE -

- If the heat pump displays a **KEYPAD LOCKED** message, the heat pump is in sleep mode. See "Wake Up Heat Pump" on page 3.
- If an entry code has already been activated, the code must be entered before proceeding to disable.

1 - Operation

IF UNIT IS ASLEEP, Swipe to wake up equipment

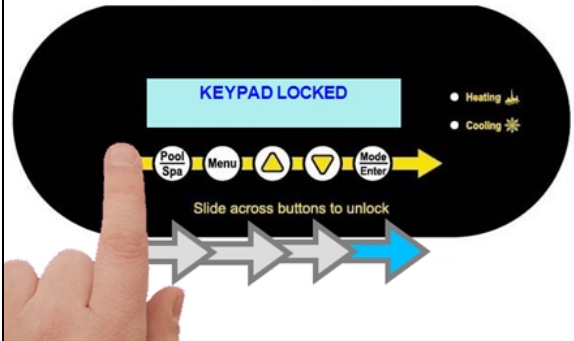

1

ARROWS TO ENTER CODE



2

ENTER TO UNLOCK

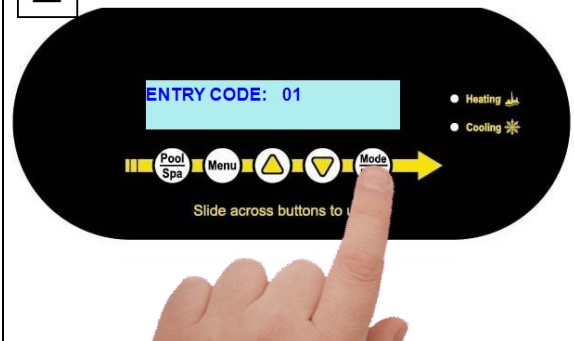

3

USE ARROWS TO MENU "SET ENTRY CODE ENABLED"

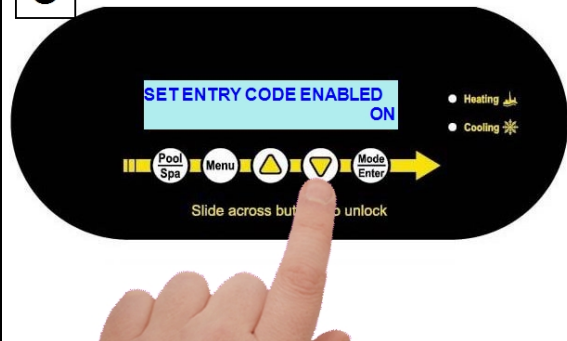

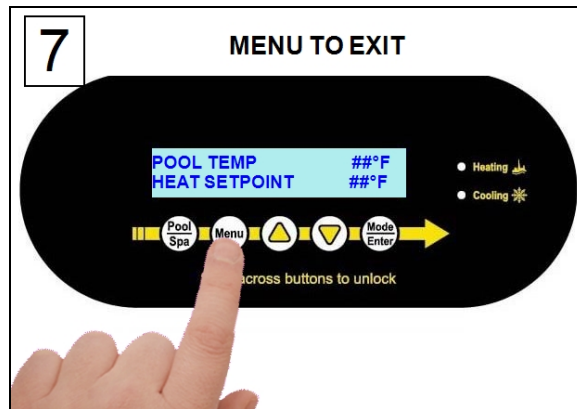
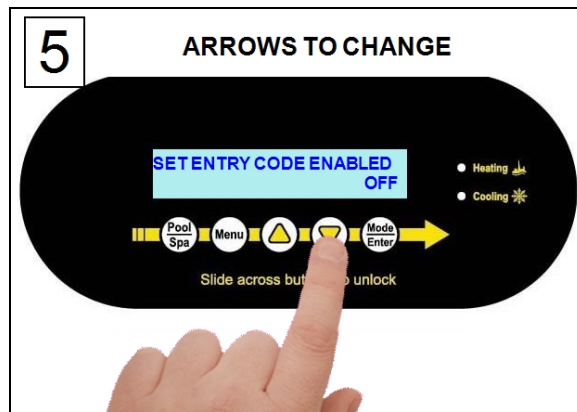
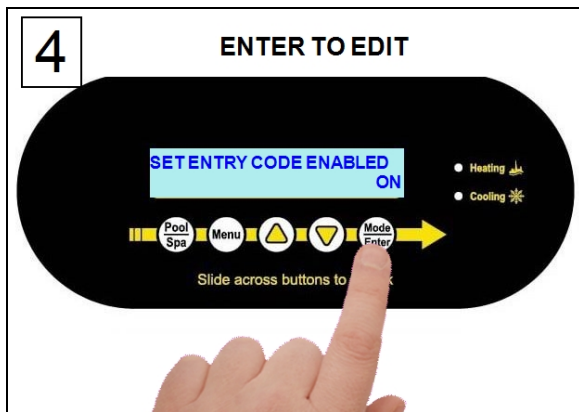

1.7 External Equipment

1.7.a Operating Heat Pump with a Call Flex

When a Call Flex has been installed and configured for a heat pump, the circulation pump will respond to commands from the heat pump. Confirm with the installer if a Call Flex accessory has been installed on the system. See "Call Flex Accessory (# 0030-LEDS)" on page 45.

- If installed, the operator has the option of changing how this accessory works using either "CALL" mode, "FLEX" mode, or "OFF" (Default).

Using Call Mode:

When the accessory is in CALL (or override) mode, the circulation pump will be set to periodically activate. This allows the heat pump to sample the water temperature.

- The default is 2 hours between each activation.
- The water temperature will be sampled for 30 seconds.
- If the water temperature has fallen below the set temperature, the circulation pump will allow the heat pump to operate until the set temperature is reached.

Using Flex Mode:

When the accessory is in **FLEX** (or extend) mode, the heat pump will start to heat if the set temperature is lower than the water temperature and the heat pump has water flow. *The circulation pump does not automatically activate in this mode.*

- If the desired water temperature has not been met by the end of the circulation pump's schedule, the normal "time-off" setting will be overridden.
- The circulation pump will continue to operate until the set temperature has been met.
- The circulation pump will then deactivate until the next normally scheduled start time.

Configure for Call mode:

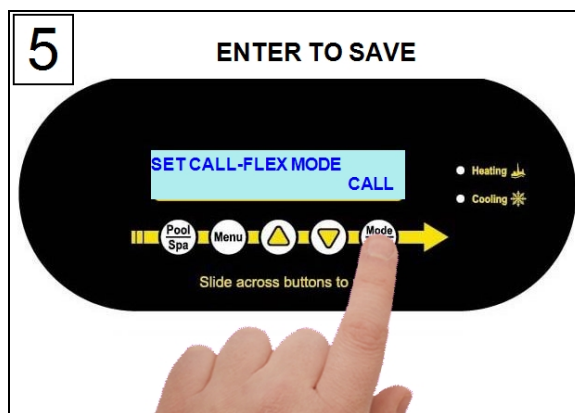
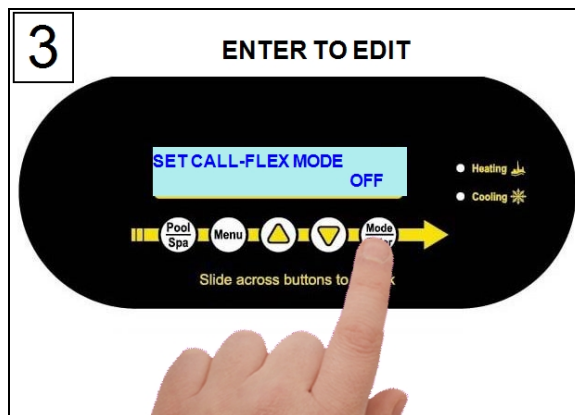
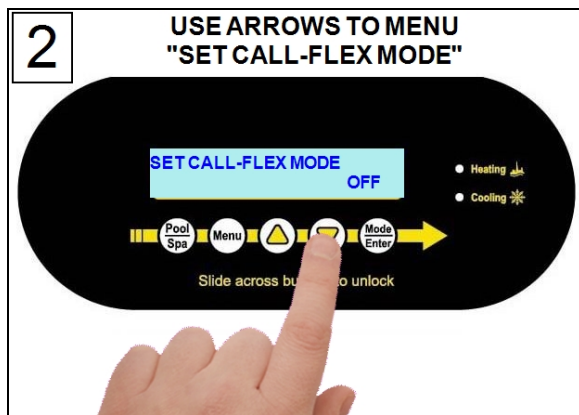
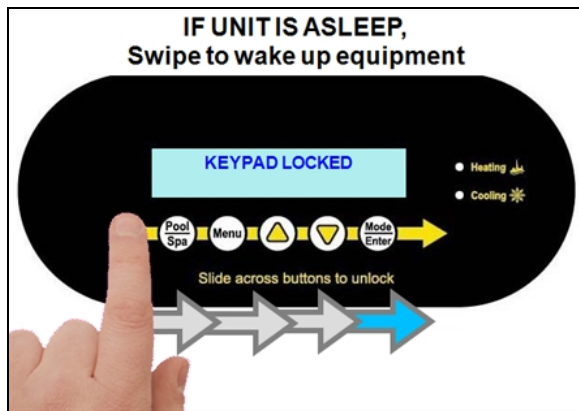

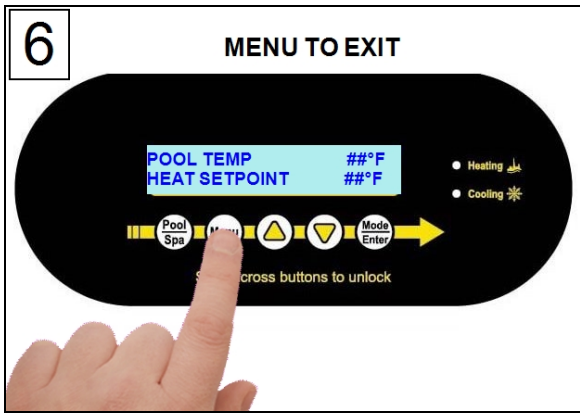

Configure for Flex mode:

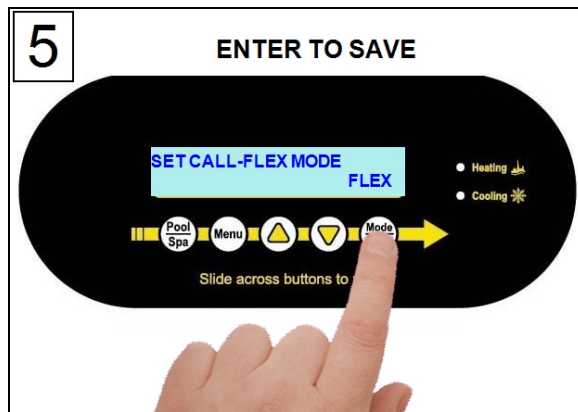
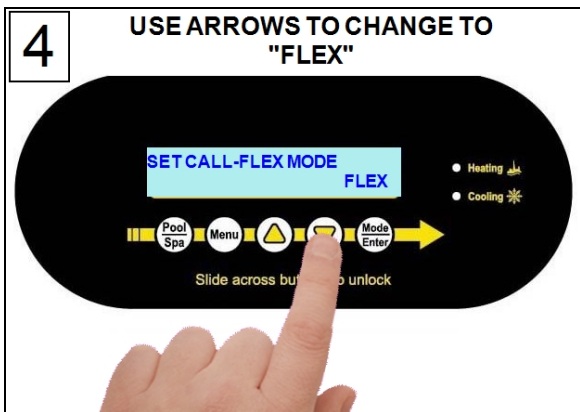
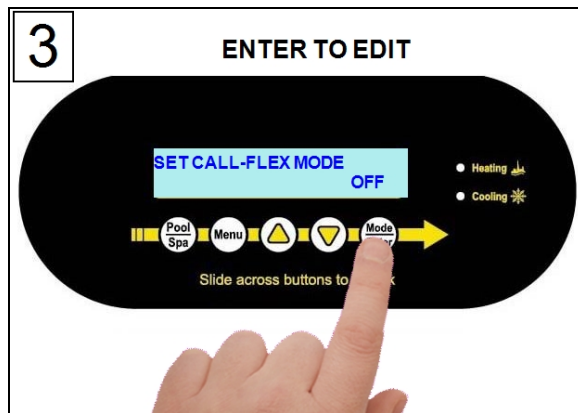
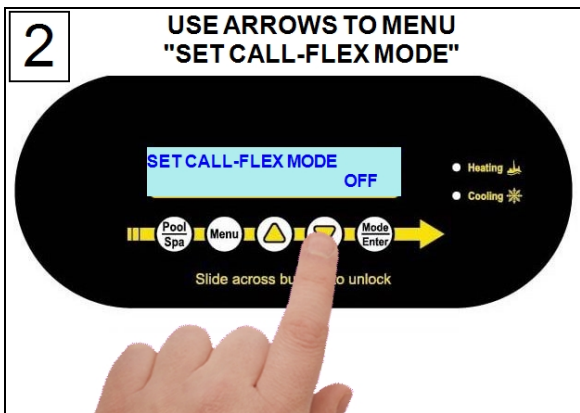
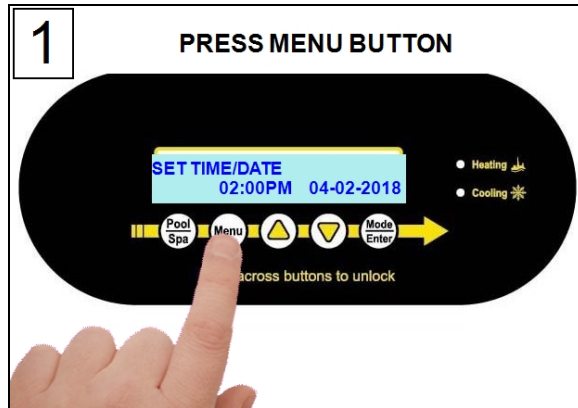
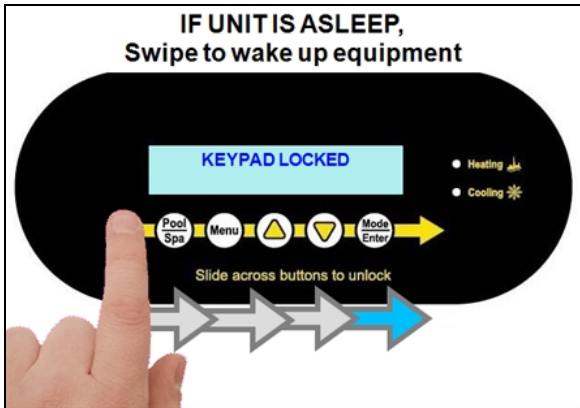

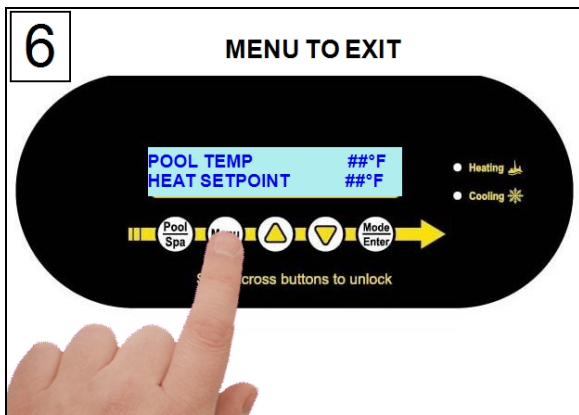

1.7.b Operating Heat Pump (With an External Controller)

If the display indicates the unit is under remote control, an external control device has been configured to control the heat pump. See external control device manual. Or contact installer or manufacturer of that device.

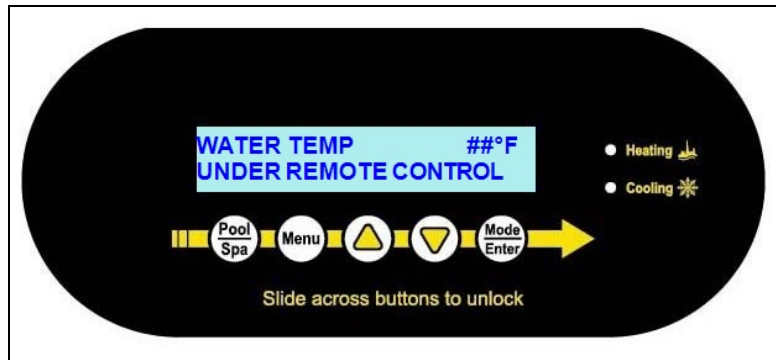

PLEASE NOTE:

When using a SMART external control device, the time-out and service modes will deactivate the Heat Pump.

1.7.c Operating Heat Pump (With an External Flow Switch)

When an external flow switch has been installed and enabled, the heat pump thermostat will automatically switch between pool and spa depending on how the water flow actuators are set. The "Pool / Spa" button will be disabled when this device is configured in the system.

Confirm with the installer if an external flow switch has been installed on the system.

1.7.d Operating Heat Pump (With a Gas Back Up)

If a gas backup heater is installed, it will be configured in one of two modes by the installer (Scheduled mode or 24 hour mode). This affects how the heater operates.

PLEASE NOTE -

*Gas backup **modes** are only available when the ambient air temperature is below 60° F. See "Using Gas Boost" on page 20 for exception.*

Scheduled Mode

When heating the Pool:

- The heat pump will operate for one hour. Then a calculation is made on how fast the water temperature is rising (a rate of rise).
- If an insufficient amount of time is provided for the heat pump to heat the water, the gas backup heater will be activated.
- When the set temperature has been reached, the gas heater will deactivate.
- The heat pump will continue to maintain the water temperature.

When heating the Spa:

- If the water temperature is lower than 2° F below the set temperature, and the ambient air temperature is below 60° F, the gas heater will activate.
- When the set temperature has been reached, the gas heater will deactivate.
- The heat pump will continue to maintain the water temperature.

24 Hour Mode

- This mode is usually used when the circulation pump runs continuously.
- The gas heater will activate when the water temperature falls 2° F below the set temperature and the ambient air temperature is below 60° F.
- When the set temperature is reached, the gas heater deactivates. The heat pump then maintains the water to the set temperature. If the water temperature again falls 2° F below the set temperature, the gas backup will reactivate.

d.1 Using Gas Boost

When a gas backup heater is installed, the user has the option of using a gas boost to heat the water quicker.

- This option is available regardless of the gas heater's configuration mode set by the installer (Scheduled Mode or 24 Hour Mode).
- When the set temperature is reached, the gas heater will deactivate. The heat pump then continues to maintain the temperature set point. The gas heater will revert to its normal mode (either 24 hour or scheduled).

PLEASE NOTE -

The "Gas boost" option is available regardless of outside air temperature.

This option, however, will only appear in the user menus when the heat pump is actively heating the water.

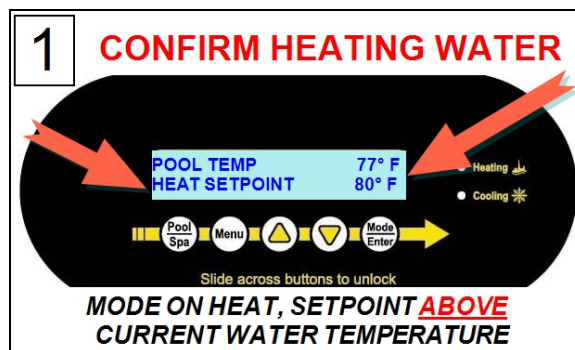
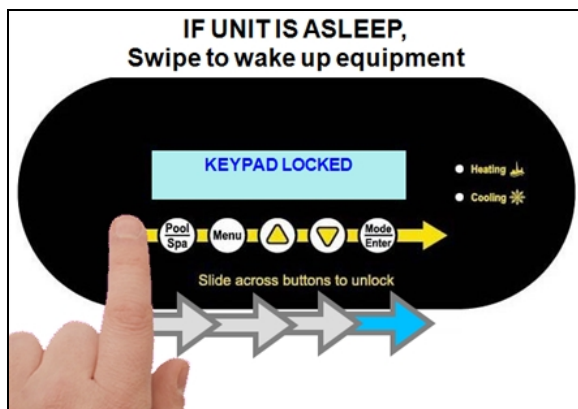

See "Setting Heat Mode" on page 6 and see "Set Temperature" on page 7.

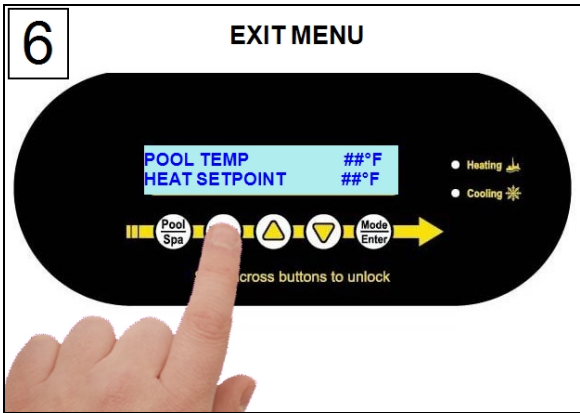
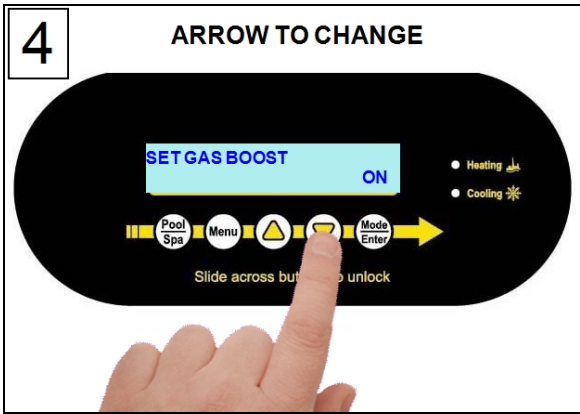
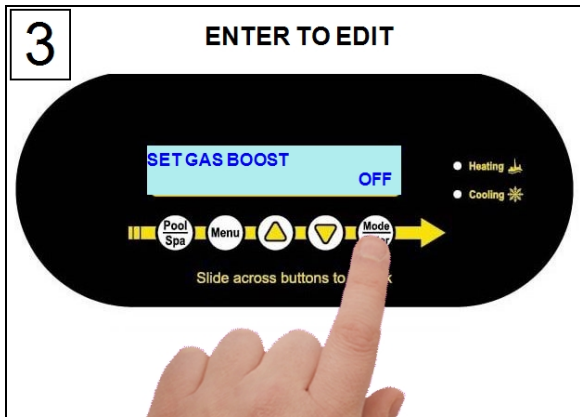
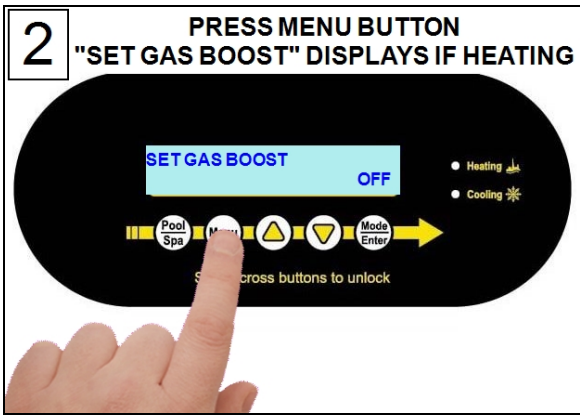

d.2 Changing a Gas Backup Heater's Schedule

PLEASE NOTE -

- When using a gas backup heater, the gas heater's schedule must match the circulation pump's schedule.
- Setting a gas backup heater schedule is only necessary when the gas backup heater has been configured in scheduled mode.

Example below shows:

**Changing START Time
from 9:00 to 8:00**

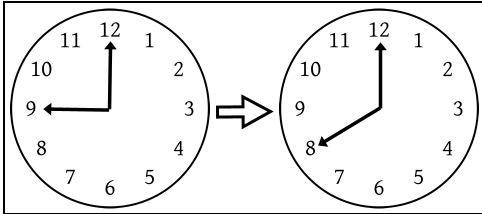

**And Changing END Time
from 5:00 to 4:00**

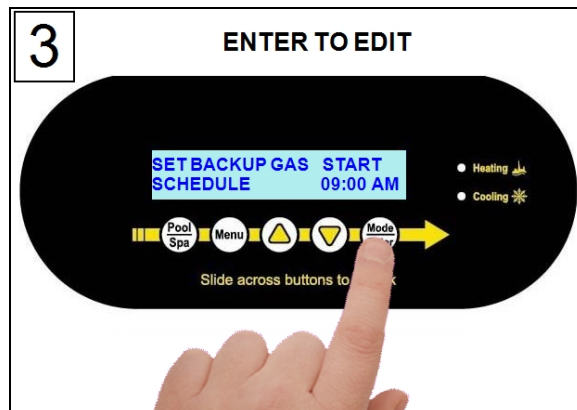
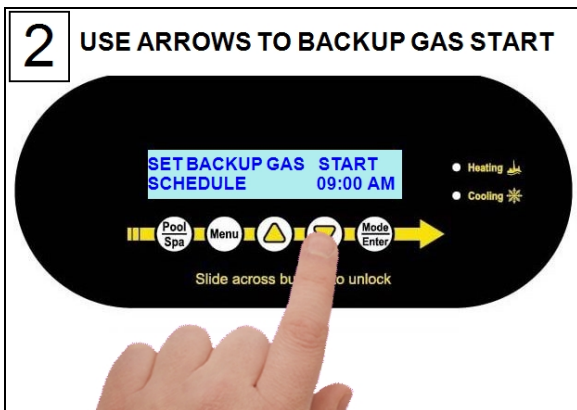
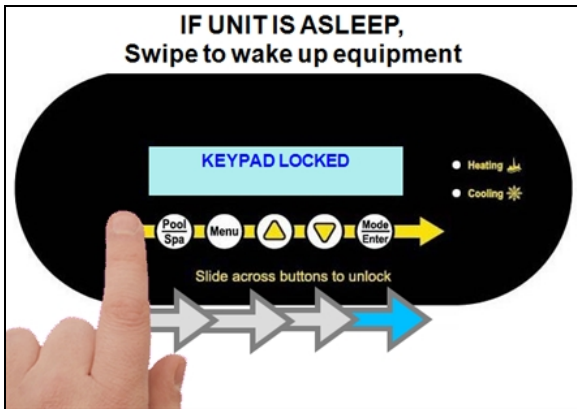
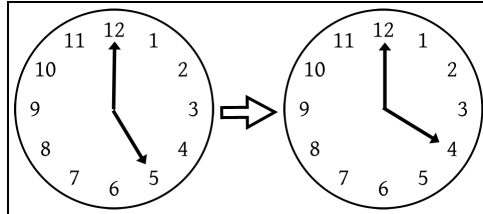

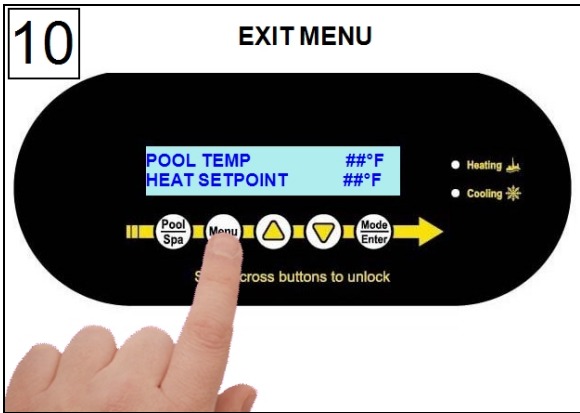
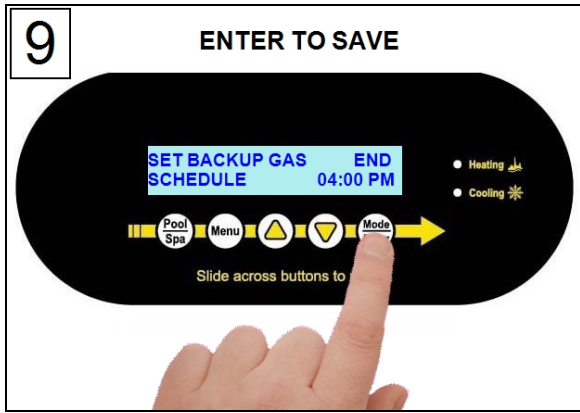
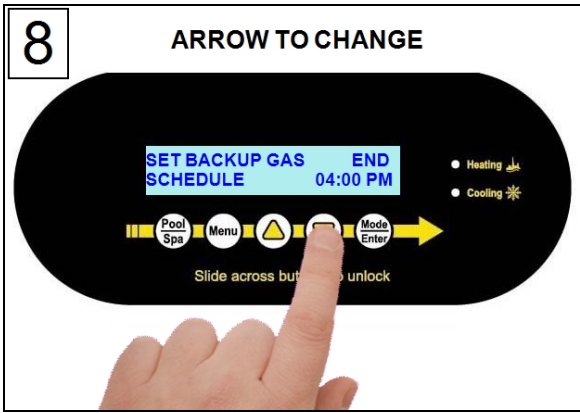
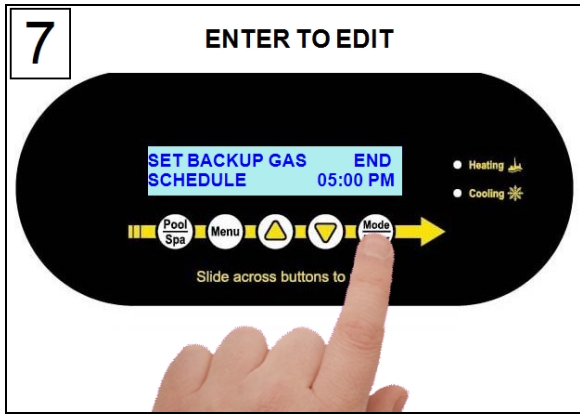
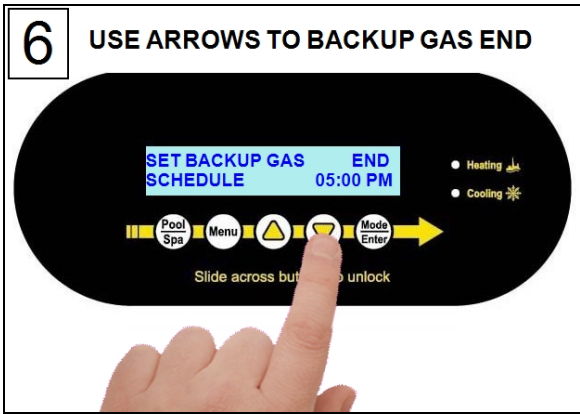
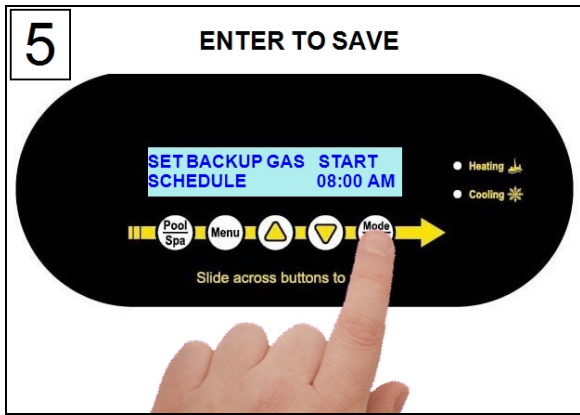
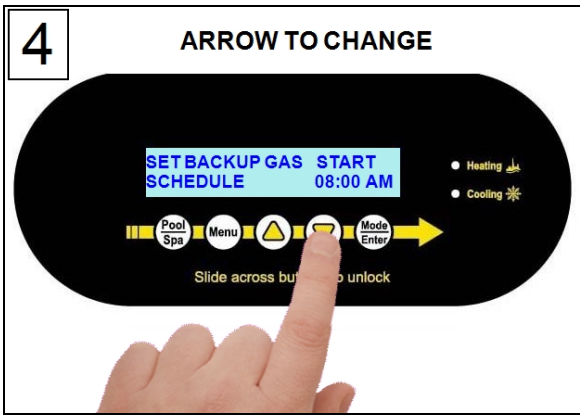

1.7.e Operating Multiple Connected Heat Pumps

Each heat pump will indicate whether it is a master or slaved unit on the display. Changes in mode and operation are made on the master (primary) heat pump only.

- The master heat pump will automatically start and stop the slaved heat pumps in a timed and controlled sequence.

Master Heat Pump

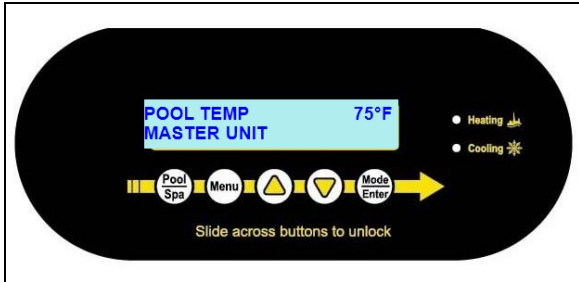

Slaved Heat Pump 01

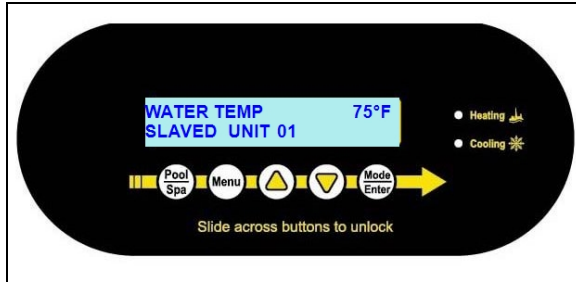

Slaved Heat Pump 02

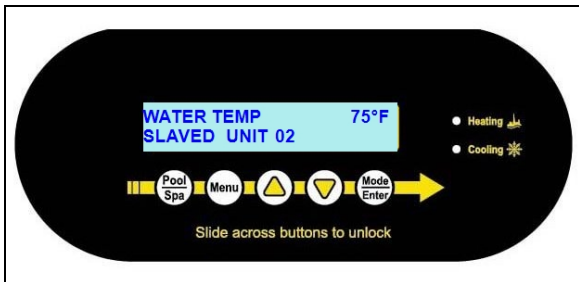

Slaved Heat Pump 03

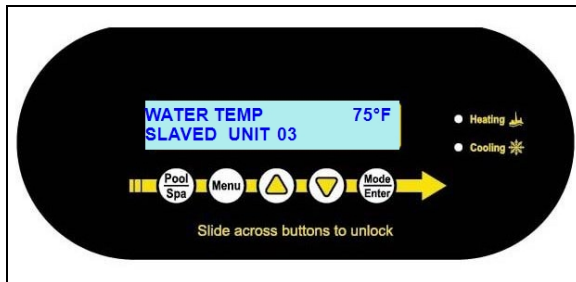

IN THIS SECTION:

2.1 Water Chemistry 25
 2.2 Cleaning Equipment 26
 2.3 Clearances 27
 2.4 Irrigation and Storm Run-Off 27
 2.5 Water Flow Rates 28
 2.6 Adjusting Water Flow Using ΔT (Delta-T) 29
 2.7 Planned Maintenance 30
 2.8 Winterizing 31

2.1 Water Chemistry

Check water chemistry regularly and maintain within recommended levels. Standards vary in different residential and commercial applications. Follow all local applicable codes.

NOTICE

Failure to heed the following may result in damage to equipment.

- Do not allow water to flow through heat pump when refinishing or acid washing a pool. Either use an installed bypass to route water away from heat pump or deactivate filter pump.
- To avoid damage to equipment, monitor and maintain chemistry within recommended levels.

CHEMISTRY LEVEL CHART (RESIDENTIAL)		
CHEMICAL	POOLS	SPAS
Chlorine	1.0 – 3.0 ppm	3.0 – 5.0 ppm
Bromine	2.0 – 6.0 ppm	2.0 – 6.0 ppm
Cyanuric Acid	30 – 50 ppm	30 – 50 ppm
pH	7.4 – 7.6	7.4 – 7.6
Total Alkalinity	80 – 120 ppm	80 – 120 ppm
Calcium Hardness	200 – 400 ppm	150 – 250 ppm
Total Dissolved Solids*	0 – 1,500 ppm	1,500 ppm above start-up of total dissolved solids in spas

* Salt from a chlorine generator is not included in Total Dissolved Solids.

2.2 Cleaning Equipment

Cleaning and polishing your heat pump regularly can protect its appearance and longevity. More frequent servicing may be required for heat pumps located in sandy or coastal areas where sand and salt spray can damage equipment.



Failure to heed the following may result in injury or death.

- Possible electric shock hazard - Deactivate power to all electrical devices on the pad when washing heat pump. Do not restore electrical power until equipment is completely dry.

NOTICE

Failure to heed the following may result in damage to equipment.

- Do not use a pressure cleaner to wash heat pump. Damage to heat pump components may result. If using a hose-end spray nozzle adjust spray pattern to low strength only.
- Do not spray water directly into the interior of the heat pump; damage to components may result.
- Do not use chemicals on the display panel.

Cleaning

1. Wash outside cabinet using a low-pressure water hose. A high-pressure water stream will cause damage to the aluminum fins of the heat pump. This damage is not covered under product warranty.
2. While the heat pump is still wet, use an approved cleaning agent to clean the exterior of the heat pump. **Do not use chemicals on the display panel.**
3. Use a detergent-dampened cloth to wipe the heat pump's exterior cabinet.
4. Flush all exterior with fresh water using a low-pressure water hose.
5. Dry the exterior cabinet using a soft cloth being careful not to damage evaporator fins being careful not to damage condenser fins.

APPROVED CLEANING AGENTS*
Fantastic®
Formula 409®
Cascade®
All Power Plain Detergent (3% Solution)

Table 1 - Cleaning Agents

- * The trademarks used in approved cleaning agents are property of their owners and are not related to AquaCal®.

Polishing

1. Polish the heat pump's cabinet panels using an approved polishing agent and following the manufacturer's instructions. Do not use chemicals on the display panel.
2. Rinse the heat pump panels with fresh water, wipe, and buff panels using a dry soft cloth.
3. Allow heat pump interior and surrounding equipment to "air-dry" for several hours prior to restoring electrical power.

APPROVED POLISHING AGENTS*

Simoniz® Wax

Glo-Coat®

Armor All® Protectant

Table 2 - Polishing Agents

- * The trademarks used in approved polishing agents are property of their owners and are not related to AquaCal®.

2.3 Clearances

- Proper air circulation is required for the heat pump to operate efficiently. The following diagrams show the minimum clearances required for the proper operation of the heat pump.
- Avoid storing chemical containers near the heat pump. The chemicals can cause equipment damage.
- Avoid placing objects near or on top of the heat pump. This includes shrubbery and lawn furniture. These objects will reduce performance and efficiency and hinder maintenance access.

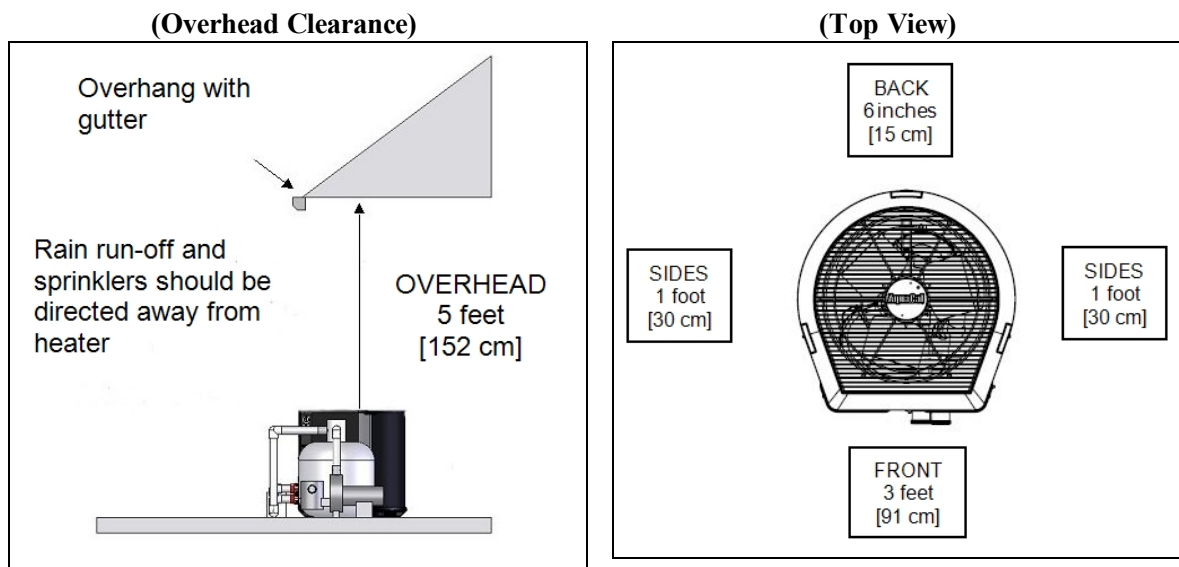

2.4 Irrigation and Storm Run-Off

- Irrigation water may damage heat pump components. Direct irrigation water away from the heat pump.
- The heat pump will withstand normal rainfall. Do not allow a roof slope to direct rainwater onto the heat pump. Have a gutter installed on the roof edge to direct this water away from the heat pump. Or install the heat pump in another location.

2.5 Water Flow Rates

Maintain water flow rates as indicated. Please note, these specifications relate to the heat pump only. Code-specified whole system turnover rates must be satisfied.

NOTICE

Failure to heed the following may result in damage to equipment.

- Water flow exceeding maximum flow rates will negatively affect the total pool filtration performance and may damage the heat pump. This will not be covered under equipment warranty.

MODEL	HEAT EXCHANGER TYPE	FLOW RATES	
		MINIMUM	MAXIMUM
SQ120R	Titanium ThermoLink®	30 GPM	70 GPM
SQ125	Titanium ThermoLink®	30 GPM	70 GPM
SQ145	Titanium ThermoLink®	30 GPM	70 GPM
SQ166R	Titanium ThermoLink®	30 GPM	70 GPM
SQ225	Titanium ThermoLink®	30 GPM	70 GPM
T035	Titanium Tube-in-Tube	20 GPM	45 GPM
T055	Titanium Tube-in-Tube	20 GPM	45 GPM
T075	Titanium Tube-in-Tube	20 GPM	45 GPM
T090	Titanium ThermoLink®	30 GPM	70 GPM
T115	Titanium ThermoLink®	30 GPM	70 GPM
T135	Titanium ThermoLink®	30 GPM	70 GPM
TC500	Titanium Tube-in-Tube	20 GPM	45 GPM
TC1000	Titanium ThermoLink®	30 GPM	70 GPM
TC1500	Titanium ThermoLink®	30 GPM	70 GPM

PLEASE NOTE -

If minimum flow rates are not met, heat pump performance is reduced and performance will suffer. Internal safety devices may deactivate the heat pump with the following errors:

- **HIGH PRESSURE FAULT**
- **HP5 SYSTEM LOCKOUT**
- **LOW PRESSURE FAULT**
- **LP5 SYSTEM LOCKOUT**

- Operate water filtration devices per manufacturer's specifications. Dirty filters can cause a reduction of water flow to the heat pump. An increase of 7-10 psi higher than the clean filter pressure typically reduces flow rates. This requires the filter to be cleaned or back-washed.
- Keep baskets free of debris. A large quantity of debris in the pump and skimmer baskets can reduce water flow.
- Check for improper valve settings. A partially closed valve after the filter, or a full-open bypass around the heat pump, will cause insufficient water flow through the heat pump.

- The maximum static pressure (or operating pressure) is 50 pounds-per-square-inch (PSI). These specifications relate to the heat pump only.
- Code-specified whole system turnover rates must be satisfied.

2.6 Adjusting Water Flow Using ΔT (Delta-T)

The Delta-T is the temperature difference between the water temperatures entering and leaving the heat pump. The equipment can be fine-tuned for maximum performance by balancing water flow rates to maintain an ideal ΔT .

- Installed temperature ports are required to perform the following procedures.
- These ports are typically located on the pool in and pool out water lines approximately six inches away from the heat pump.
- **The adjustment procedure must be completed with the unit in heating mode.**

PLEASE NOTE -

- The installation of temperature ports are required for all commercial applications.
- The installation of temperature ports are strongly recommended for residential installations.
 - See "Temperature Port Kit (# STK0096)" on page 47.

1. Adjust thermostat to its lowest setting with unit in heating mode.
2. Deactivate the water filtration pump.
3. Confirm that the filters leading to the heat pump are clean.
4. Adjust the valves controlling water headed towards the heat pump to the half open position.
5. Adjust the valves controlling water leading away from the heat pump to a fully open position.
6. Activate the pool water filtration pump.
7. Slowly raise the thermostat temperature until the heat pump activates.
 - After a four-minute delay, the heat pump's compressor will start.
8. With the heat pump running, confirm water filtration pump is operating properly with adequate flow and no short cycling.
9. Wait for water temperatures to stabilize (approximately 5 minutes).
10. Adjust valves in the following order using the temperature chart provided:
 - a. Adjust the valve that controls water exiting the heat pump. Match the temperature measured with a temperature probe to the chart.
 - b. Wait for water temperatures to stabilize. Then check temperature again. Re-adjust the valve as needed.
11. Mark valves at these positions for future reference.

**Temperature Port
(Shown with Probe)**



MODEL	TEMPERATURE
SQ120R	3° to 7° F
SQ125	3° to 7° F
SQ145	3° to 7° F
SQ166R	3° to 8° F
SQ225	4° to 9° F
T035	1° to 4° F
T055	2° to 5° F
T075	3° to 7° F
T090	3° to 6° F
T115	3° to 7° F
T135	4° to 8° F
TC500	2° to 5° F
TC1000	2° to 5° F
TC1500	3° to 7° F

Table 3 - Temperature Chart

PLEASE NOTE -

- Temperature differences are based on pool water temperatures of 69° to 75° F.
- For water temperatures outside this range, contact AquaCal®. See "Contacting AquaCal AutoPilot, Inc." on page 1.

2.7 Planned Maintenance

An annual inspection and maintenance program is strongly recommended starting no later than one year after installation of the heat pump. In harsh environments or coastal areas a bi-annual inspection is recommended. See recommended inspection checklist.

AquaCal® can perform this service in limited areas. Contact Customer Support for more information.



Failure to heed the following may result in injury or death.

- Annual inspection and service must be performed by a qualified heat pump specialist in order to prevent physical injury or damage to equipment. For tasks requiring handling refrigerant, an HVAC license is required.

Recommended Inspection Checklist:
1. Clean Evaporator Coil
2. Clean Condenser Coil
3. Check Contactor Points
4. Check Fan Capacitor Values
5. Check Fan Blade Clearances

Recommended Inspection Checklist:
6. Clean Heat Pump Cabinet
7. Check Flow / Pressure Switch
8. Apply Rust Inhibitors (As applicable)
9. Verify / Check Air Flow Delta
10. Verify / Check Water Flow Delta
11. Check Fan Motor Amperage Draw
12. Check and Clear Condensate Drains
13. Check Compressor Capacitor Values
14. Check Compressor Amperage Draw
15. Check Internal Electrical Connections
16. Check Operating Refrigerant Pressures (As Applicable)
17. Check Ambient and Water Temperature Sensors
18. Check Proper Line and Control Voltage to Unit
19. Identify Insect and Rodent Issues with Unit
20. Identify Environmental Conditions of Concern (Run-Off, Sprinklers, etc.)
21. Perform Operating Orientation (As Applicable)

2.8 Winterizing

Failure to properly winterize the heat pump as needed may result in serious equipment damage.



WARNING

Failure to heed the following may result in injury or death.

- Deactivate all electrical power to heat pump before performing hard freeze procedures.

NOTICE

Failure to heed the following may result in damage to equipment.

- Failure to winterize heat pump may result in serious equipment damage. Freeze damage is not covered under the heat pump warranty.
- While the plumbing connections are in the winterized condition (not fully tightened), it is imperative that water not run through the heat pump. Loss of water through loose plumbing connections may result in damage to circulation pump, pool and spa structures, and other equipment.

Light Freeze Conditions

A light freeze is when the ambient air temperature falls below 32 degrees Fahrenheit for less than 8 hours. Typically during light freeze conditions circulating (or moving) water will not freeze. Temporarily activate the filter pump for continuous operation during light freeze conditions.

Hard Freeze Conditions

A hard freeze is when the ambient air temperature falls below 32 degrees Fahrenheit for more than 8 hours. In areas where this condition is prevalent and sustained, the heat pump **MUST** be winterized for hard freeze conditions. Follow the correct procedure depending on the type of heat exchanger found in the heat pump.

Identify Exchanger:

1. Deactivate all electrical power to heat pump.
2. Deactivate filter pump.
3. Remove front access panel.
4. Identify heat exchanger from illustrations in this section. Then follow procedure for the appropriate heat exchanger.

Titanium ThermoLink[®] Exchanger (with no Drain)

5. Reinstall front access panel.
6. Disconnect the plumbing to the heat pump at connection unions (removal is counter-clockwise).
7. Allow water to drain completely from the heat pump. Expect to see a lot of water drain out at first, and then a small amount to continue to drain out over a long period.
8. After heat pump has fully drained, partially reconnect plumbing connection unions.
9. Winterizing is complete.
10. When ready to use heat pump again, hand-tighten connection unions. Reconnect electrical power, and set the operating mode on the heat pump. Activate filter pump.

No Drain



Titanium Tube-in-Tube Exchanger

5. Reinstall front access panel.
6. Disconnect the plumbing to the heat pump at connection unions (removal is counter-clockwise).
7. Allow water to drain completely from the heat pump. Expect to see a lot of water drain out at first, and then a small amount to continue to drain out over a long period.
8. Place an air hose into the water inlet of the heat pump; wrap a clean rag around the hose to form a temporary seal.
9. Push all water from the water circuit using compressed air no stronger than 50 psig. The residual water should be forced out of the heat pump's water outlet. Allow compressed air to blow into the heat pump inlet for at least 15-20 seconds after the water stops coming out.
10. Repeat process on the outlet side of the heat pump.
11. Partially reconnect plumbing connection unions.
12. Winterizing is complete.
13. When ready to use heat pump again, hand-tighten connection unions. Reconnect electrical power, and set the operating mode on the heat pump. Activate filter pump.

**Titanium
Tube-in-
Tube**

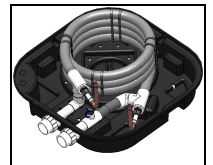

IN THIS SECTION:

Fault Codes

AIR TEMP SENSOR OPEN or AIR TEMP SENSOR SHORT	34
CLOCK LOW BATTERY	34
DEFROST1 SENSOR SHORT or DEFROST2 SENSOR SHORT	34
DEFROST1 SENSOR OPEN or DEFROST2 SENSOR OPEN	34
ERROR AT MASTER UNIT	34
HIGH PRESSURE FAULT	35
HP5 SYSTEM LOCKOUT	35
HIGH WATER TEMPERATURE	35
LOW PRESSURE FAULT	36
LP5 SYSTEM LOCKOUT	36
MULTI-UNIT COMM FAULT	36
OTA SYSTEM LOCKOUT	36
SMART COMM FAULT	37
WATER TEMP SENSOR SHORT or WATER TEMP SENSOR OPEN	37

Issues and resolutions

Displays "DEFROSTING"	38
Displays "NO SYSTEM FIRMWARE"	38
Displays "NO WATER FLOW"	38
Displays "SET TO SWITCH REMOTELY"	38
Displays "SET UNIT MODEL NUMBER"	38
Display Panel Not Responding	39
Heat Pump Not Running	39
Heat Pump's Tripping Breaker	39
Heat Pump Won't Shut Off	39
Heat Pump Is Running, Not Heating	40
Heat Pump Is Running, Not Cooling (Heat and Cool Models)	40
Ice Forming on the Heat Pump	41
"Pool / Spa" Button Will Not Work	41
Water Coming From Heat Pump	42

3.1 Fault Codes

A fault code indicates a specific issue or condition that will require action before the equipment can resume operating.

Please perform the following troubleshooting.

If the issue reoccurs, please see *"Contacting AquaCal AutoPilot, Inc." on page 1.*



WARNING

Failure to heed the following may result in injury or death.

- Repairs must not be attempted by untrained or unqualified individuals.
- The heat pump contains refrigerant under high pressure. Repairs to the refrigerant circuit must not be attempted by untrained or unqualified individuals. Service must be performed only by qualified HVAC technicians. Recover refrigerant before opening the system.

NOTICE

Failure to heed the following may result in damage to equipment.

- Service by unauthorized personnel will void the heat pump warranty.

AIR TEMP SENSOR OPEN or AIR TEMP SENSOR SHORT

ISSUE

Open or shorted air sensor.

RESOLUTION

A qualified technician should replace the air sensor.

CLOCK LOW BATTERY

ISSUE

The real-time clock controller indicates a low battery condition.

- The time will reset to factory default.
- If connected, a gas backup heater may start and stop at an incorrect time when set for "SCHEDULED" mode.

RESOLUTION

1. A qualified technician should replace the clock battery on the heat pump's microprocessor.
2. The technician should reset the date and time after replacing battery.

DEFROST1 SENSOR SHORT or DEFROST2 SENSOR SHORT

ISSUE

Shorted defrost sensor.

RESOLUTION

A qualified technician should replace the defrost sensor.

DEFROST1 SENSOR OPEN or DEFROST2 SENSOR OPEN

ISSUE

Open defrost sensor.

RESOLUTION

A qualified technician should replace the defrost sensor.

ERROR AT MASTER UNIT

ISSUE

The heat pump is slaved to a master heat pump that is displaying a fault code.

RESOLUTION

The error at the master heat pump must be corrected before the slaved unit will resume operation.

HIGH PRESSURE FAULT

ISSUE

The refrigerant system's high-pressure switch is showing as open.

RESOLUTION

Heat Only Units and Heat and Cool Units (Reversing)

If the heat pump is a reversing unit, place it in heating mode and perform the following troubleshooting.

Determine if an insufficient amount of water is being supplied to the equipment.

1. Confirm the filter pump is on.
2. If a multiple-speed filter pump is being used, run filter pump at a higher speed. Do not exceed maximum flow rate for the model.
3. Confirm water is not being diverted away from the heat pump.
 - See "Water Flow Rates" on page 28.
 - See "Adjusting Water Flow Using ΔT (Delta-T)" on page 29.

Cool Only Units

Determine if an insufficient amount of air is being supplied to the equipment.

1. Check for proper fan operation. If fan is not operating, contact AquaCal® Technical Support.
2. Check for obstructed air flow around the heat pump.
 - See "Clearances" on page 27.
3. Check for dirty or blocked evaporator coil.
 - See "Cleaning Equipment" on page 26.

HP5 SYSTEM LOCKOUT

ISSUE

The heat pump has locked due to five high-pressure faults during one call for heating or cooling.

RESOLUTION

1. Deactivate then reactivate power to the heat pump to clear error.
2. Troubleshoot the high-pressure issue causing the error.
 - See "HIGH PRESSURE FAULT" on page 35.

HIGH WATER TEMPERATURE

ISSUE

Incoming water temperature exceeded 110° F and the unit is locked with a high temperature fault. The heat pump will not operate until incoming water temperature drops to 100° F or lower.

This is normal when water is currently being heated by a direct solar thermal system.

RESOLUTION

1. Determine if another heat source (gas heater, etc.) is heating water being sent directly to the heat pump with the over temperature indicator. This situation will need to be corrected before continuing.
2. Rule out an incorrect reading from the water temperature sensor. Verify existing water temperature with an accurate thermometer. If heat pump's sensor is inaccurate, the water temperature sensor may require replacement.

LOW PRESSURE FAULT

ISSUE

The refrigerant system's low-pressure switch is showing as open.

RESOLUTION

Heat Only Units and Heat and Cool Units (Reversing)

If the heat pump is a reversing unit, place it in heating mode and perform the following troubleshooting.

1. Check for proper fan operation. If fan is not operating, contact AquaCal® Technical Support.
2. Check for obstructed air flow around the heat pump.
 - See "Clearances" on page 27.
3. Check for dirty or blocked evaporator coil.
 - See "Cleaning Equipment" on page 26.
4. Check for signs of heavy ice buildup on the coil.

Cool Only Units

Determine if an insufficient amount of water is being supplied to the equipment.

1. Confirm the filter pump is on.
2. If a multiple-speed filter pump is being used, run filter pump at a higher speed. Do not exceed maximum flow rate for the model.
3. Confirm water is not being diverted away from the heat pump.
 - See "Water Flow Rates" on page 28.
 - See "Adjusting Water Flow Using ΔT (Delta-T)" on page 29.

LP5 SYSTEM LOCKOUT

ISSUE

The heat pump has locked due to five low-pressure faults during one call for heating or cooling.

RESOLUTION

1. Deactivate then reactivate power to the heat pump to clear error.
2. Troubleshoot the low-pressure issue causing the error.
 - See "LOW PRESSURE FAULT" on page 36.

MULTI-UNIT COMM FAULT

ISSUE

Slaved heat pump is not receiving a signal from the master heat pump.

RESOLUTION

1. Confirm master heat pump is operating correctly. If for example, no power is supplied to the master heat pump, an error will appear on the slaved heat pumps.

OTA SYSTEM LOCKOUT

ISSUE

A malfunction has occurred that could allow the water temperature to surpass a safe level. The "Over Temperature Alarm" kit has disabled the system.

RESOLUTION

Call for service.

SMART COMM FAULT

ISSUE

Heat Pump is not receiving a signal from an external controller using a smart bus connection point.

RESOLUTION

1. Confirm a smart bus external controller is being used.
 - If unsure, contact installer of heat pump for more information. The heat pump may need to be reconfigured to set external controller to "none".
2. If using a smart bus external controller, confirm the controller is correctly set to send signals to the heat pump. See manuals or guides provided with external controller.

WATER TEMP SENSOR SHORT or WATER TEMP SENSOR OPEN

ISSUE

Shorted or open water sensor.

RESOLUTION

A qualified technician should replace the water sensor.

3.2 Issues and Resolutions



WARNING

Failure to heed the following may result in injury or death.

- Repairs must not be attempted by untrained or unqualified individuals.
- The heat pump contains refrigerant under pressure. Repairs to the refrigerant circuit must not be attempted by untrained or unqualified individuals. Service must be performed only by qualified HVAC technicians. Recover refrigerant before opening the system.

NOTICE

Failure to heed the following may result in damage to equipment.

- Service by unauthorized personnel will void the factory warranty.

Please perform the following troubleshooting.

For further assistance, please see "*Contacting AquaCal AutoPilot, Inc.*" on page 1.

Displays "DEFROSTING"

The heat pump has sensed the evaporator coil is icing up. See "Ice Forming on the Heat Pump" on page 41.

No action is required.

Heat and Cool Units - Active Defrost

Hot refrigerant gas will be sent through the coil to rapidly remove ice or frost.

During this process, the melting of the ice may appear as steam coming off the heat pump. This is normal.

Heat Only Units - Passive Defrost

When ice starts to form on the coil, the compressor will stop operating while the fan continues to operate.

- The evaporator coil will begin to warm to the surrounding air temperature. When the coil's temperature rises above 38° F, the compressor is restarted and heating or cooling resumes.
- If the coil's temperature remains below 38° F, the compressor will remain off.

Displays "NO SYSTEM FIRMWARE"

The heat pump has encountered a software error.

Call for service.

Displays "NO WATER FLOW"

Low or no water detected. This is normal when circulation pump is deactivated.

1. Confirm the filter pump is on.
2. If a multiple-speed filter pump is being used, run at a higher speed to determine if the error persists. Do not exceed maximum flow rate for your model.
3. Confirm water is not being diverted away from the heat pump.
 - See "Water Flow Rates" on page 28.
 - See "Adjusting Water Flow Using ΔT (Delta-T)" on page 29.

Displays "SET TO SWITCH REMOTELY"

If when pressing the "Pool / Spa" button the display flashes the message "**SET TO SWITCH REMOTELY**", the heat pump is using a remote relay switch or a 3-wire controller.

- The Pool and Spa thermostat automatically switch when using these modes.
- Manual operation will not be available when using these external devices. No action is required.

Displays "SET UNIT MODEL NUMBER"

The heat pump has encountered a software error.

- The model number and serial number will need to be reentered into the system. The system will then operate as normal.
 - See "Identifying Model Specifications" on page 43.
- If the issue reoccurs, please contact the distributor or installing dealer.

Display Panel Not Responding

1. If heat pump display shows "**UNDER REMOTE CONTROL**", use external control device to control heat pump.
2. If needed, check with external controller manufacturer for further assistance using that device.

Heat Pump Not Running

1. Confirm equipment is receiving power. Is the heat pump display illuminated?
 - If not, confirm the main breaker (located at the power supply panel) and the disconnect switch (located near the heat pump) are both turned on.
 - If the display still does not illuminate, it is recommended that the heat pump installer or electrician confirms heat pump is receiving power.
2. Confirm correct mode is selected.
 - See "Activate Heat Mode, Cool Mode, Auto Mode, or Deactivate Equipment" on page 6.
3. Confirm thermostat is set correctly.
 - See "Set Temperature" on page 7.
 - When heating the water is desired, the thermostat should be set above the current water temperature.
 - When cooling the water is desired, the thermostat should be set below the current water temperature.
4. If an error code is displayed, diagnose and correct the cause of the code.
 - See "Fault Codes" on page 33.
5. If the heat pump is using an external controller, the heat pump may not be set correctly to accept the controller's signal.
 - See "Operating Heat Pump (With an External Controller)" on page 19

Heat Pump's Tripping Breaker

1. Have an electrician confirm breakers are correct type, in good condition, and properly sized for the heat pump.
2. If AquaCal® heat pumps have been connected to each other using a multiple heat pump configuration, the configuration may be incorrect. Please confirm settings or contact installer of equipment.

Heat Pump Won't Shut Off

PLEASE NOTE

When heat pump is set to off, the display will show the current water temperature or no water flow indicator.

1. Confirm the correct mode has been set on the heat pump.
 - See "Activate Heat Mode, Cool Mode, Auto Mode, or Deactivate Equipment" on page 6.
2. Confirm the heat pump has reached the desired temperature set on the thermostat. The heat pump will continue to run until the set temperature is reached.
 - See "Set Temperature" on page 7.
3. If the heat pump is using an external controller, it may not be set correctly. See external controller's manual.

Heat Pump Is Running, Not Heating

1. If the heat pump is using an external controller, confirm it is set correctly.
 - See "Operating Heat Pump (With an External Controller)" on page 19.
 - If the heat pump is still not running correctly with this device, contact the installer of the external controller device or the device's manufacturer for further assistance.
2. Confirm heat pump mode is set to heat.
3. Confirm thermostat is set to the desired water temperature.
4. Confirm valves are positioned to heat the correct body of water (either the pool or the spa). If heating a spa that overflows into a pool, confirm the spa is isolated when being heated (not flowing into the pool).
5. Confirm heat pump is transferring heat into the water.
 - Measure the temperature of air discharge coming out of the heat pump fan. If discharge air is between 8° to 10° colder than the outside ambient air, the heat pump is moving heat into the water.
6. If an error code is displayed, diagnose and correct cause of code.
 - See "Fault Codes" on page 33.
7. Confirm that filter pump has a sufficient run-time. The heat pump will not run (or heat the water) without water flow.
 - See "Heating Recommendations" on page 44.
8. If heating a spa, deactivate air blower or venturi (if equipped) to allow for quicker heating times. For pools, deactivate water features, such as slides, waterfalls, or fountains to allow water to retain heat. Use of a liquid pool blanket product, such as Aqua Blanket™, can also compensate for excessive heat loss.
 - See "Liquid Blankets" on page 46.

Heat Pump Is Running, Not Cooling (Heat and Cool Models)

1. If the heat pump is using an external controller, confirm the heat pump is programmed properly to allow for cooling.
 - See "Operating Heat Pump (With an External Controller)" on page 19.
2. Confirm the heat pump mode is set to cool.
3. Confirm the thermostat is set below the current water temperature.
4. Confirm valves are positioned to cool the correct body of water (either the pool or the spa). If cooling a spa that overflows into a pool, confirm the spa is isolated when being cooled (not flowing into the pool).
5. If an error code is displayed, determine and correct the condition causing the code.
 - See "Fault Codes" on page 33.
6. Confirm heat pump is transferring heat out of the water.
 - Measure the temperature of air discharge coming out of heat pump's fan. If the air is between 8° to 10° warmer than the outside ambient air, the heat pump is moving heat out of the water.
7. Confirm that filter pump has a sufficient run-time. The heat pump will not run (or cool the water) without water flow.
 - See "Cooling Recommendations" on page 45.

Ice Forming on the Heat Pump

When conditions are too cold for proper operation, the heat pump will enter a defrost mode. This prevents ice from building up on the evaporator coil.

Heat Only Units:

- The heat pump may develop a fine layer of white frost on the outside coil before entering the defrost mode. This is normal.
 - See "Displays "DEFROSTING"" on page 38.
- If heavy ice (not frost) starts to build up, shut off the heat pump. Contact the installer or manufacturer.
- If the ambient air temperature will be falling below 32° F for more than 8 hours, winterize equipment.
 - See "Winterizing" on page 31.

Heat and Cool Units (with Active Defrost or “Icebreaker”):

- During freezing conditions, pool or spa heating will continue. Frost or ice may develop during the “countdown” to the active defrost (up to 50 minutes). This is normal. See "Displays "DEFROSTING"" on page 38.
- The heat pump will enter an "active defrost" stage to remove the accumulated frost and ice. See "Displays "DEFROSTING"" on page 38.
 - Be sure to observe the unit for at least 50 minutes. If it has not entered an active defrost cycle, call for service.

TIP:

The heat pump can be manually set to defrost by temporarily switching to the cooling mode until the ice or frost melts.

- If the ambient air temperature is (or will be) falling below 32° F for more than 8 hours, winterize equipment.
 - See "Winterizing" on page 31.

Cool Only Units

- The heat pump may enter defrost mode if the water flow rate falls below the acceptable range. See "Water Flow Rates" on page 28.
- If the ambient air temperature will be falling below 32° F for more than 8 hours, winterize equipment.
 - See "Winterizing" on page 31.

"Pool / Spa" Button Will Not Work

The "Pool / Spa" button is disabled if the following devices have been configured on the heat pump. Check with installer if unsure of devices enabled on heat pump.

- A 2-wire external controller.
- A 3-wire external controller.
- An external flow switch.

Water Coming From Heat Pump

The water may be normal condensation produced as a by-product of the heat pump's refrigeration process. The heat pump can produce 8 to 10 gallons of condensation per day depending on the humidity of the ambient air. Determine if the water is condensation or a possible leak.

1. Deactivate heat pump, leaving the filter pump on. After several hours, determine if water is still coming from the heat pump.
2. If using chlorine or bromine as a pool / spa sanitizer, test the water around the heat pump using a test strip. If the test strip indicates that chlorine or bromine is present, a leak may exist.

PLEASE NOTE -

If desired, a kit is available to re-direct condensation water away from the heat pump.

- See "Condensation Drain Kit (# STK0202)" on page 45.

4 - Appendix

IN THIS SECTION:

4.1 Identifying Model Specifications	43
4.2 Weights	44
4.3 Heating Recommendations	44
4.4 Cooling Recommendations	45
4.5 Available Accessories	45

4.1 Identifying Model Specifications

1. Find Data Plate - The data plate is usually posted on the side of the equipment or the inside of the heat pump's access plate.
2. Find the model number on the data plate. The first letters and numbers indicate the model type.
3. The complete model number identifies the equipment's specifications.

Data Plate Example

MINIMUM CIRCUIT AMPACITY <input type="text"/>	MADE IN THE USA				
ELEC. SERVICE: VOLTS <input type="text"/> PH <input type="text"/> HZ <input type="text"/>					
MAXIMUM TIME DELAY FUSE OR HACR BREAKER <input type="text"/> 5					
COMPRESSOR VOLTS <input type="text"/> R.L.A. <input type="text"/> L.R.A. <input type="text"/>					
FAN MOTOR VOLTS <input type="text"/> H.P. <input type="text"/> F.L.A. <input type="text"/>					
REFRIGERANT: Circuit - Factory charged <input type="checkbox"/> Only oz/Kg <input type="text"/>					
Tested to <input type="text"/> psig High side / <input type="text"/> psig Low side					
OUTDOOR UNIT					
AQUA CAL, INC A TEAM HORNER COMPANY 2737 24 TH STREET NORTH ST. PETERSBURG, FL 33713 FACTORY SERVICE 727-523-5642	<table border="1"> <tr> <td>MODEL NUMBER <input type="text"/></td> </tr> <tr> <td style="text-align: center;">IIIBAR CODEIII</td> </tr> <tr> <td>SERIAL NUMBER <input type="text"/></td> </tr> <tr> <td style="text-align: center;">IIIBAR CODEIII</td> </tr> </table>	MODEL NUMBER <input type="text"/>	IIIBAR CODEIII	SERIAL NUMBER <input type="text"/>	IIIBAR CODEIII
MODEL NUMBER <input type="text"/>					
IIIBAR CODEIII					
SERIAL NUMBER <input type="text"/>					
IIIBAR CODEIII					

Model Number Example

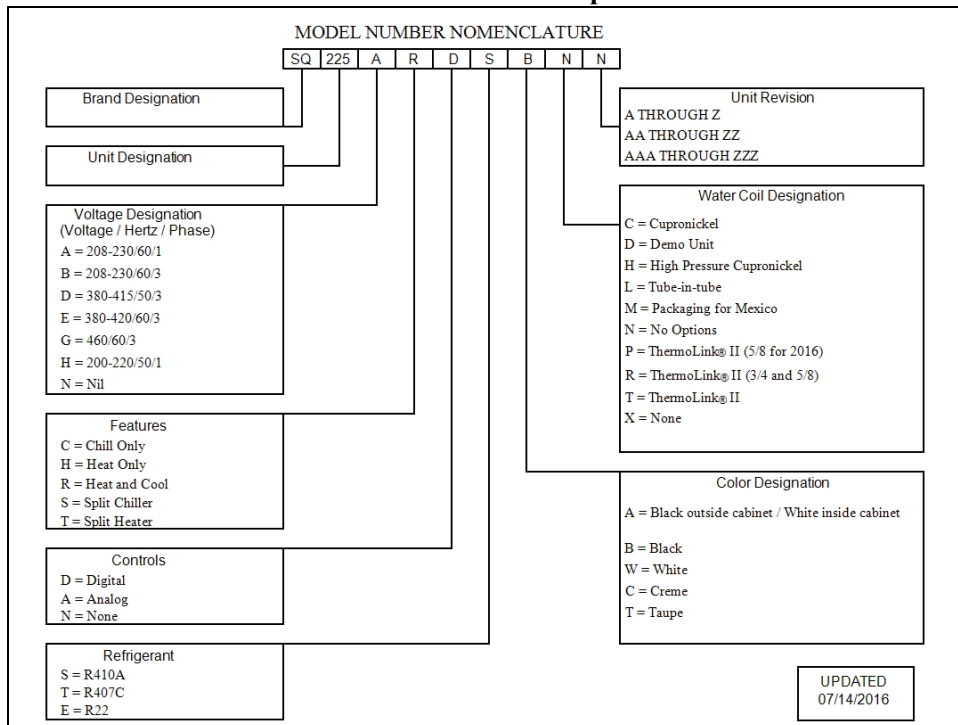

4.2 Weights

NOTE:

Specifications subject to change.

Model Type	Model Number	Install Weight
TropiCal®	T035	180 Pounds
TropiCal®	T055	180 Pounds
TropiCal®	T075	200 Pounds
TropiCal®	T090	255 Pounds
TropiCal®	T115	259 Pounds
TropiCal®	T135	287 Pounds
HeatWave SuperQuiet®	SQ120R	268 Pounds
HeatWave SuperQuiet®	SQ125	268 Pounds
HeatWave SuperQuiet®	SQ145	328 Pounds
HeatWave SuperQuiet®	SQ166R	328 Pounds
HeatWave SuperQuiet®	SQ225	328 Pounds
TropiCool®	TC500	215 Pounds
TropiCool®	TC1000	285 Pounds
TropiCool®	TC1500	328 Pounds

Table 4 - Equipment Weight

4.3 Heating Recommendations

The following recommendations will reduce the amount of time required to heat a pool. **If unsure of equipment heating capability, review equipment data plate.** See "Identifying Model Specifications" on page 43.

1. Confirm heat pump mode has been set to heating mode.
2. Set a desired temperature (set point) for the water.
3. Temporarily set the filter pump for continuous operation.
 - This will allow the Heat Pump the time required to heat the water at start-up.
 - After the water has reached the desired temperature, reset the filter pump to normal operating time-frames.
4. Use a pool cover or blanket to reduce heating time.

4.4 Cooling Recommendations

The following recommendations will reduce the amount of time required to cool a pool or cold plunge application. **If unsure of equipment cooling capability, review equipment data plate.** See "Identifying Model Specifications" on page 43.

1. Confirm heat pump mode has been set to cooling mode.
2. Set thermostat to desired water temperature.
3. Temporarily set the filter pump for continuous operation.
 - This will allow the Heat Pump the time required to cool the water at start-up.
 - After the water has reached the desired temperature, reset the filter pump to normal operating time-frames.

4.5 Available Accessories

Accessories may be purchased through an authorized dealer of AquaCal® products.

Bypass Valve Kit (# STK0135)

- When high flow rates are outside recommended specifications, please use this kit or an alternative bypass valve system.
- This kit can be used to control excessive water flow through the heat pump. It provides automatic flow adjustments for most applications.



Condensation Drain Kit (# STK0202)

- Used when condensation water flow must be directed to a specific location.



Call Flex Accessory (# 0030-LEDS)

- This accessory will override a circulation pump to provide water to the heat pump when the set temperature is not met.

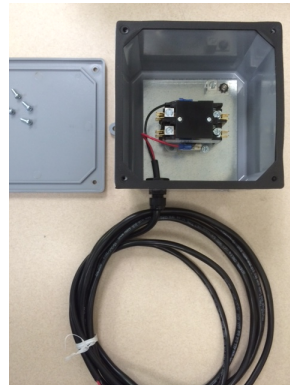

Grid Flow Switch (# 0040S)

- Used for automatic pool / spa thermostat switching.
- This switch can also be used in place of the water pressure switch. This may be needed when the pool / spa elevation is higher than the heat pump. A higher elevation of the water can cause a false signal to the heat pump; indicating water is flowing through the heat pump when it isn't.
- This kit is not to be used on applications exceeding 50 PSI.



Liquid Blankets

- An invisible liquid heat barrier designed to retain heat and extend the swimming season.
- AquaCal® recommends [Lo-Chlor®](#) Aqua Blanket™.



Over Temperature Alarm Kit

- This kit is an additional safety device. It disables the heat pump if any malfunction occurs that allows the water temperature to surpass a safe level.
- This kit is strongly recommended for all spa applications.
 - Single Phase Heat Pump - (# STK0221)
 - Three Phase Heat Pump - (# STK0222)

Plumbing Unions

- 2 Inch Unions - (# PLS2627)



Temperature Port Kit (# STK0096)

- This port can be used to adjust water flow using Delta-T.
- The kit comes with port, installation components, and a temperature probe.

